

CB12, 22 & 32 water boilers.
 Prices exclude packing, carriage & VAT

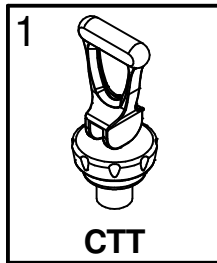

CTT
 TWIN CAM TAP TOP ASSEMBLY
 PRICE £20.80

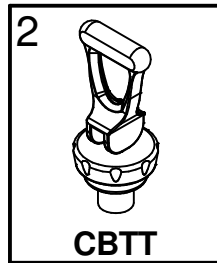

CBTT
 SINGLE CAM TAP TOP ASSEMBLY
 PRICE £20.80

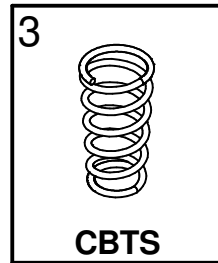

CBTS
 TAP SPRING
 PRICE £5.20

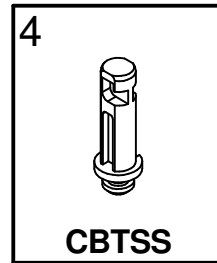

CBTSS
 TAP SLOTTED STEM
 PRICE £2.80

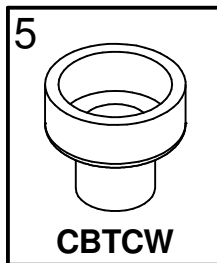

CBTCW
 TAP CUP WASHER
 PRICE £4.80

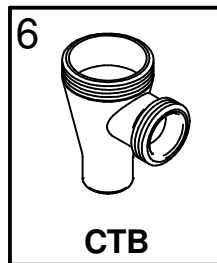

CTB
 DRAW OFF TAP BODY (NO EXTENSION)
 PRICE £36.00

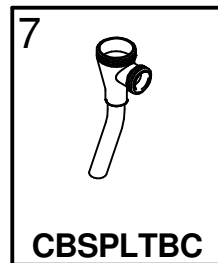

CBSPLTBC
 DRAW OFF TAP BODY (50mm EXTENSION)
 PRICE £38.00

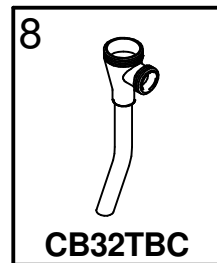

CB32TBC
 DRAW OFF TAP BODY (100mm EXTENSION)
 PRICE £38.00

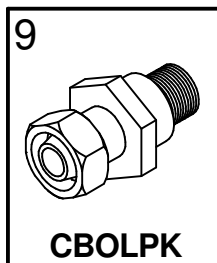

CBOLPK
 OUTLET LINER PIPE KIT (inc lid gasket)
 PRICE £64.00

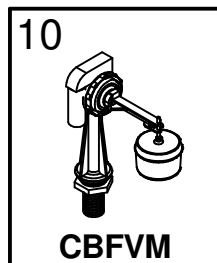

CBFVM
 FLOAT VALVE ASSEMBLY
 PRICE £21.90

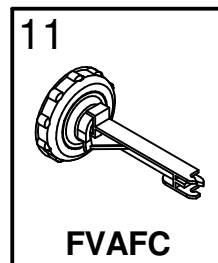

FVAFC
 FLOAT VALVE ARM AND CAP
 PRICE £6.60

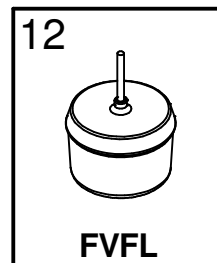

FVFL
 FLOAT VALVE FLOAT
 PRICE £2.90

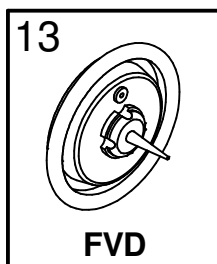

FVD
 FLOAT VALVE DIAPHRAGM
 PRICE £4.80

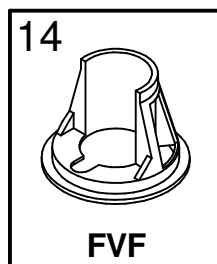

FVF
 FLOAT VALVE FILTER
 PRICE £3.80

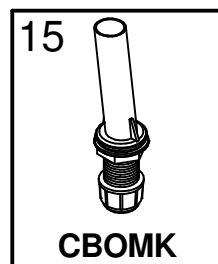

CBOMK
 OVERFLOW UNIT
 PRICE £12.00

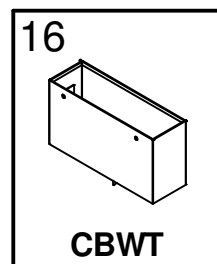

CBWT
 WATER TANK
 PRICE £32.00

CB12, 22 & 32 water boilers.
 Prices exclude packing, carriage & VAT

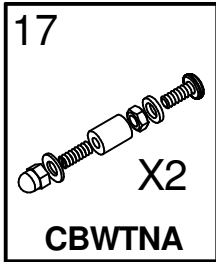

WATER TANK NUT ASSEMBLY
 PRICE £8.00

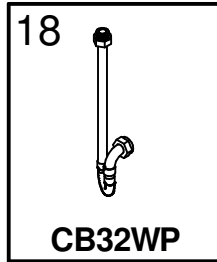

WATER PIPE
 PRICE £38.60

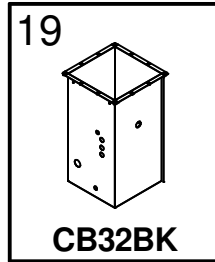

BODY KIT
 P.O.A

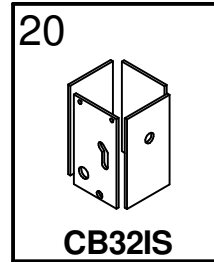

INSULATION SET
 PRICE £21.00

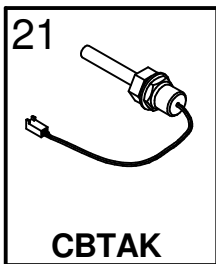

TOP/BOTTOM THERMISTOR ASSEMBLY
 PRICE £28.00

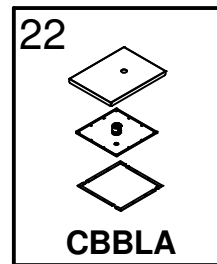

BODY LID ASSEMBLY
 PRICE £66.00

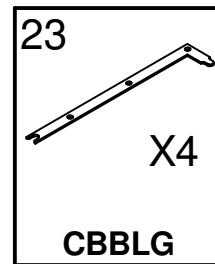

BODY LID GASKET
 PRICE £4.20

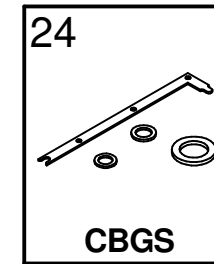

GASKET SET
 PRICE £13.00



ELEMENT 1,2 or 3kW
 WITH STAT POCKET
 PRICES: 1KW £42.00
 2KW £42.00
 3KW £38.00

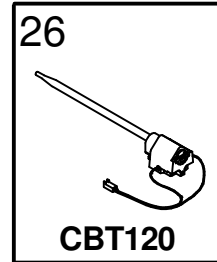

SAFETY CUTOUT
 SET TO 120 °C
 PRICE £18.00

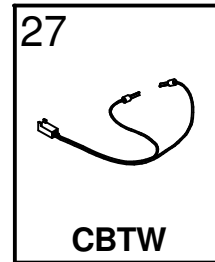

SAFETY CUTOUT WIRE
 PRICE £3.60

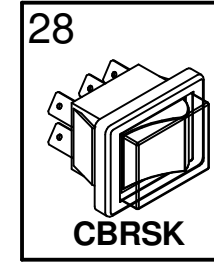

ECONOMY SELECTOR SWITCH KIT
 PRICE £12.60

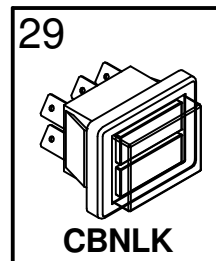

2 LIGHT INDICATOR UNIT KIT
 PRICE £13.20

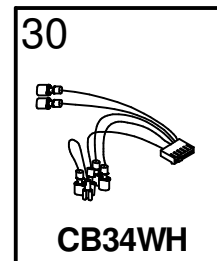

WIRING HARNESS
 PRICE £10.40

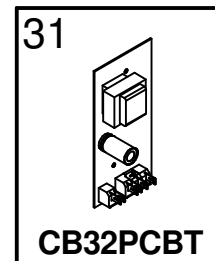

PRINTED CIRCUIT BOARD
 PRICE 89.65

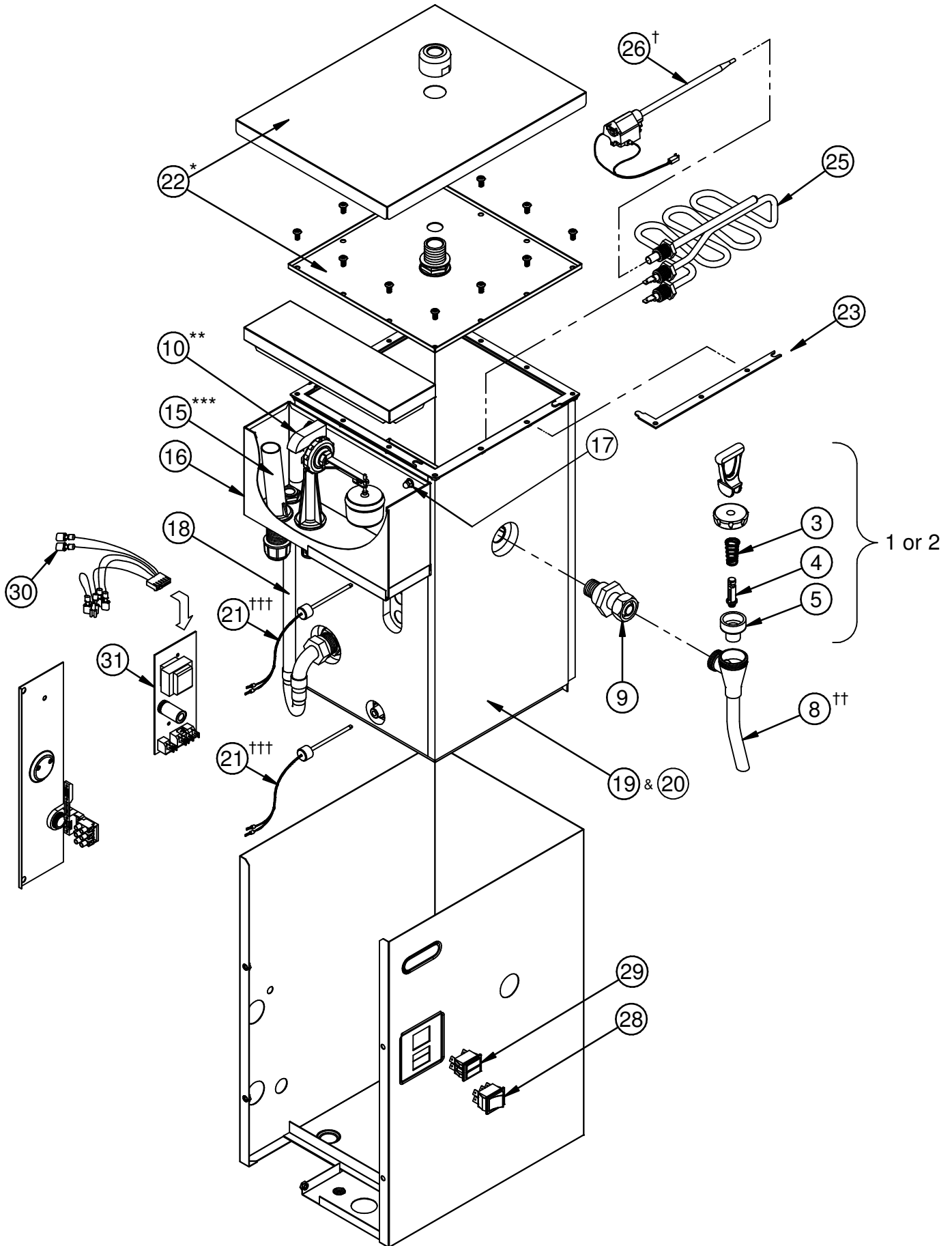

* Complete assembly
 ** Incorporating 11, 12, 13 & 14
 *** Supplied with insect filter & gaskets

† Includes 28
 †† Fitted as standard, 6 or 7 as alternatives
 ††† Includes thermistor pocket, all washers & nuts