

Contour water boilers.  
Prices exclude packing, carriage & VAT

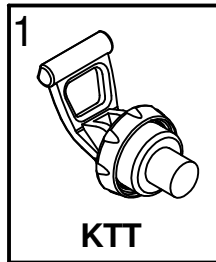

**KTT**  
TAP TOP  
ASSEMBLY  
PRICE: £16.70

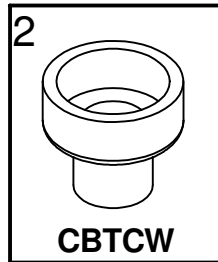

**CBTCW**  
TAP CUP WASHER  
PRICE: £3.90

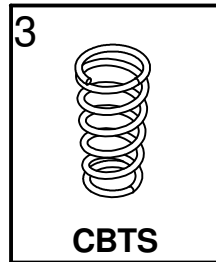

**CBTS**  
TAP SPRING  
PRICE: £3.60

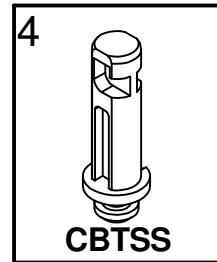

**CBTSS**  
TAP SLOTTED  
STEM  
PRICE: £2.60

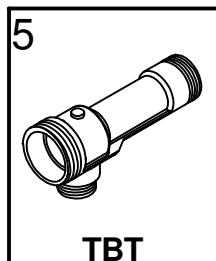

**TBT**  
DRAW OFF TAP  
BODY  
PRICE: £29.40

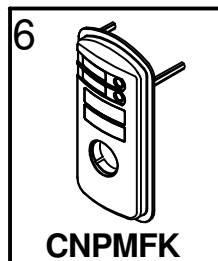

**CNPMFK**  
PLASTIC MOULDED  
FASCIA KIT  
PRICE: £17.00

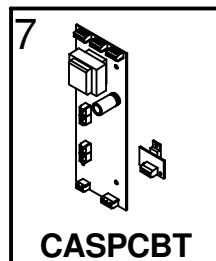

**CASPCBT**  
PRINTED CIRCUIT  
BOARD Inc. TRIAC  
PRICE: £88.30

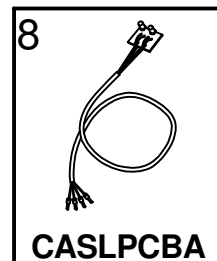

**CASLPCBA**  
LIGHT PCB  
PRICE: £8.70

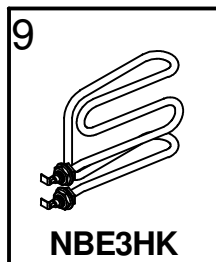

**NBE3HK**  
ELEMENT 3kW  
PRICE: £22.60

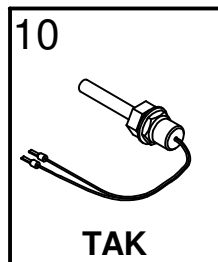

**TAK**  
THERMISTOR  
ASSEMBLY KIT  
PRICE: £19.70

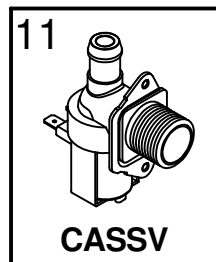

**CASSV**  
SOLENOID VALVE  
PRICE: £14.80

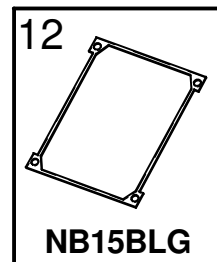

**NB15BLG**  
BODY LID GASKET  
PRICE: £5.60

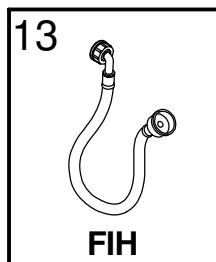

**FIH**  
WATER INLET  
HOSE  
PRICE: £9.80

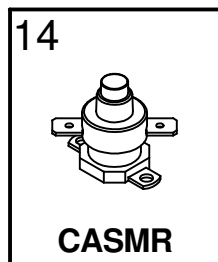

**CASMR**  
MANUAL RESET  
THERMAL CUTOUT  
PRICE: £9.60

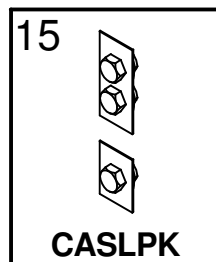

**CASLPK**  
LEVEL PROBES KIT  
PRICE: £21.20

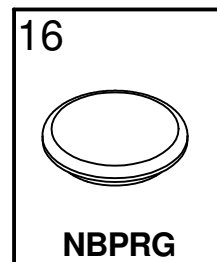

**NBPRG**  
PRESSURE RELIEF  
GROMMET  
£2.90

Contour water boilers.

Prices exclude packing, carriage & VAT

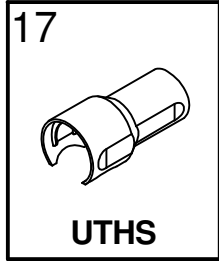

TAP BODY HEAT  
SHIELD  
PRICE £8.80

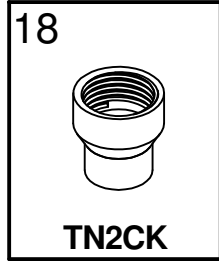

SLOW-FILL NOZZLE  
FITTED AS STANDARD  
PRICE £5.80

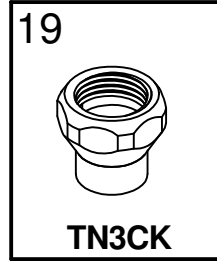

FAST-FILL NOZZLE  
(ALTERNATIVE)  
PRICE £7.40

Contour water boiler  
Exploded parts view

If parts required are not identified, please contact Calomax Limited

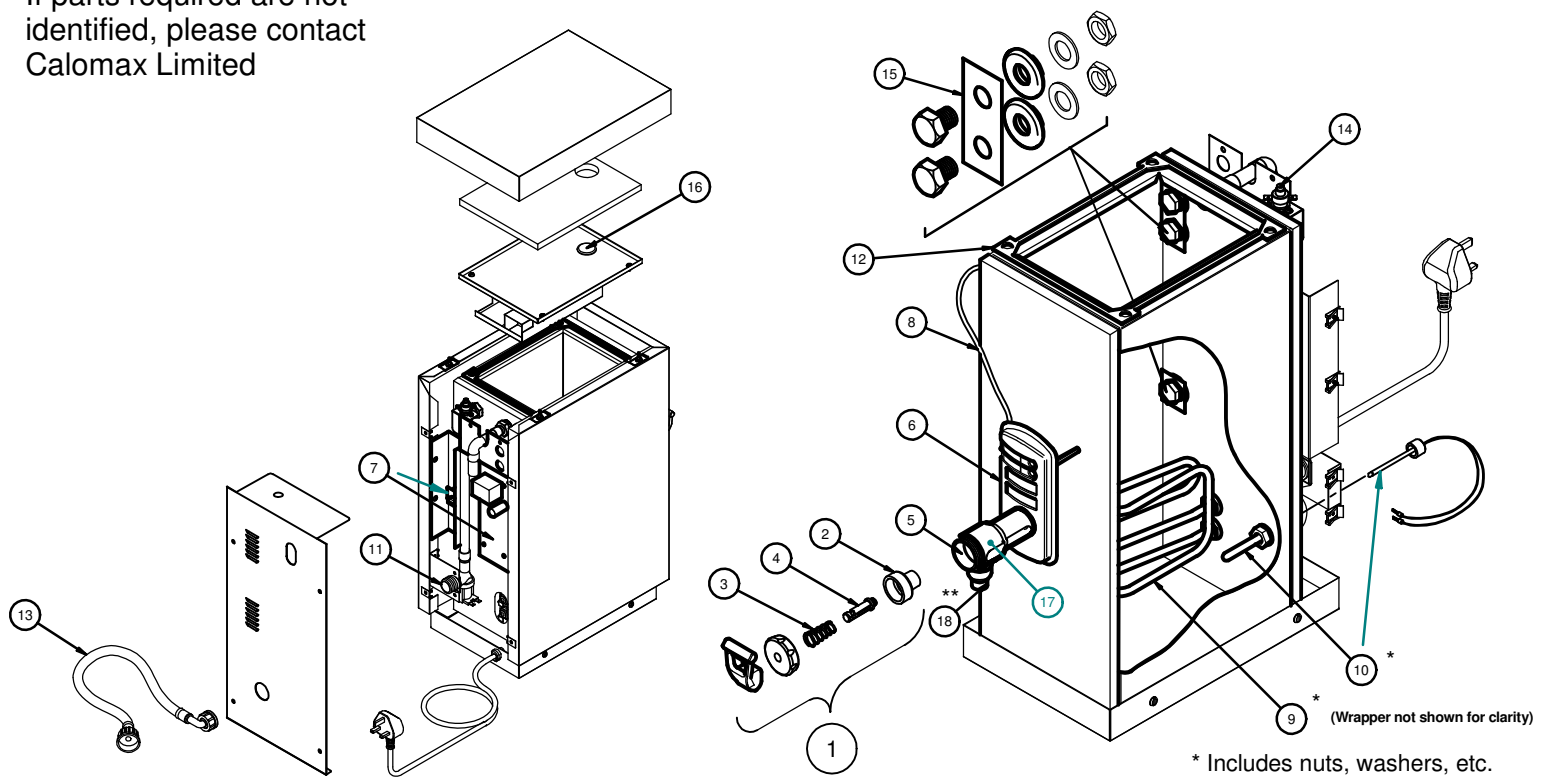

\* Includes nuts, washers, etc.  
\*\* Alternative Fast Flow nozzle available