

Contour water boilers.
 Prices exclude packing, carriage & VAT

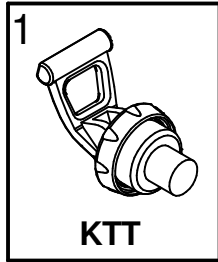

KTT
 TAP TOP
 ASSEMBLY
 PRICE: £20.80

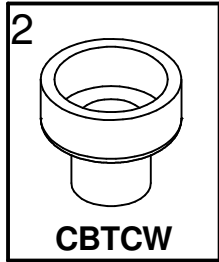

CBTCW
 TAP CUP WASHER
 PRICE: £4.80

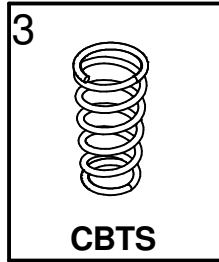

CBTS
 TAP SPRING
 PRICE: £5.20

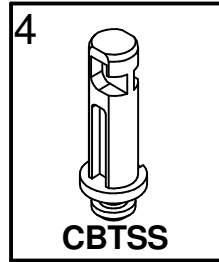

CBTSS
 TAP SLOTTED
 STEM
 PRICE: £2.80

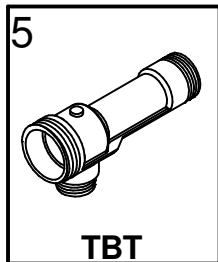

TBT
 DRAW OFF TAP
 BODY
 PRICE: £36.00

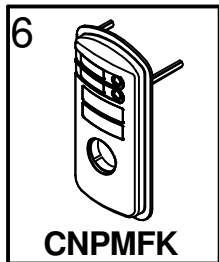

CNPMFK
 PLASTIC MOULDED
 FASCIA KIT
 PRICE: £21.00

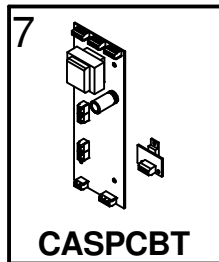

CASPCBT
 PRINTED CIRCUIT
 BOARD Inc. TRIAC
 PRICE: £95.50

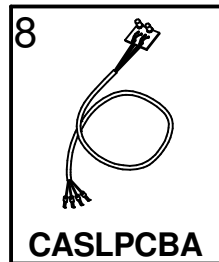

CASLPCBA
 LIGHT PCB
 PRICE: £10.40



NBE3HK
 ELEMENT 3kW
 PRICE: £35.00

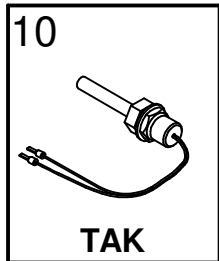

TAK
 THERMISTOR
 ASSEMBLY KIT
 PRICE: £26.20

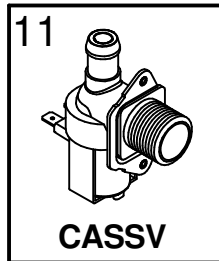

CASSV
 SOLENOID VALVE
 PRICE: £17.40

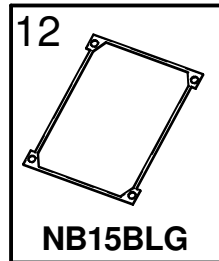

NB15BLG
 BODY LID GASKET
 PRICE: £6.40

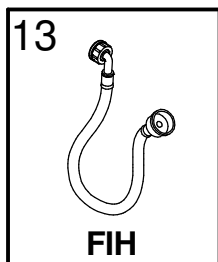

FIH
 WATER INLET
 HOSE
 PRICE: £10.60

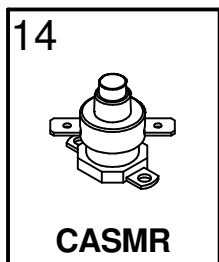

CASMR
 MANUAL RESET
 THERMAL CUTOUT
 PRICE: £11.60

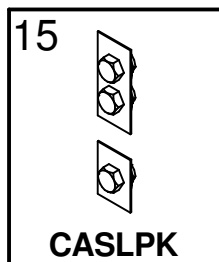

CASLPK
 LEVEL PROBES KIT
 PRICE: £27.00

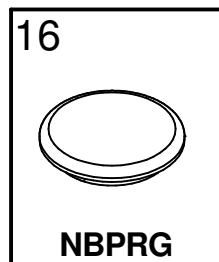

NBPRG
 BODY LID
 GROMMET
 £2.90

Contour water boilers.
Prices exclude packing, carriage & VAT

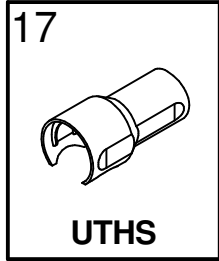

TAP BODY HEAT
SHIELD
PRICE £9.80

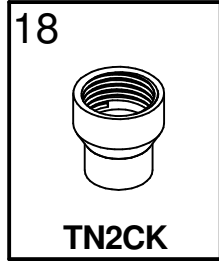

SLOW-FILL NOZZLE
FITTED AS STANDARD
PRICE £10.80

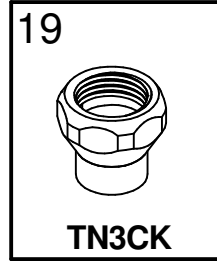

FAST-FILL NOZZLE
(ALTERNATIVE)
PRICE £11.40

Contour water boiler
Exploded parts view

If parts required are not identified, please contact Calomax Limited

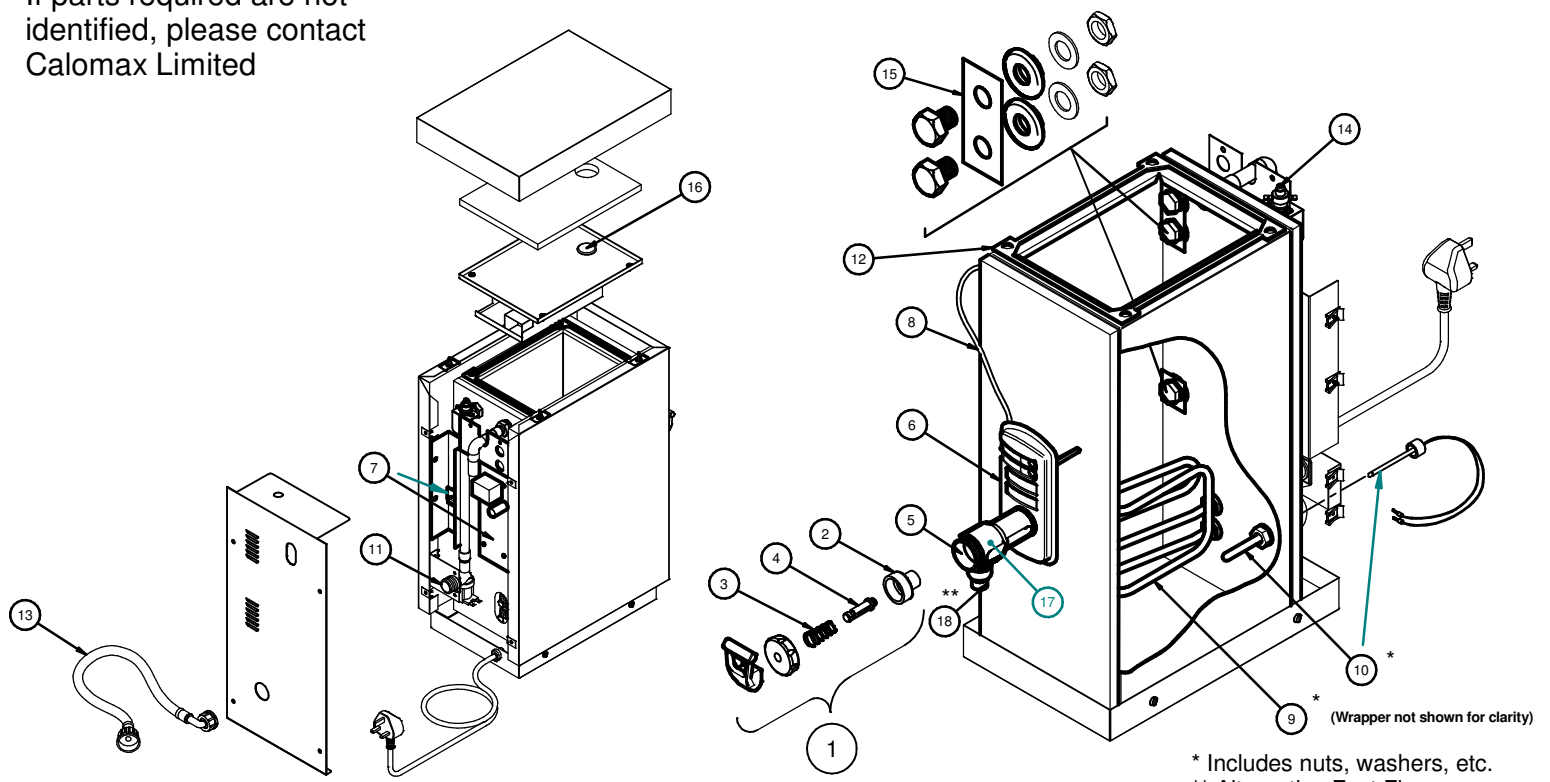

* Includes nuts, washers, etc.
** Alternative Fast Flow nozzle available