

Cascade water boiler.

Prices exclude packing, carriage & VAT

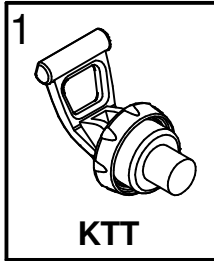

TAP TOP ASSEMBLY
PRICE: £20.80

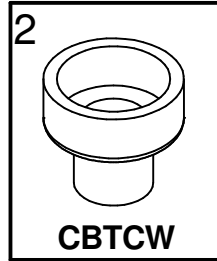

TAP CUP WASHER
PRICE: £4.80

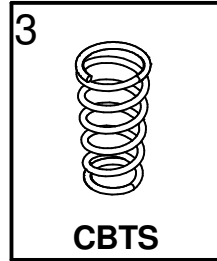

TAP SPRING
PRICE: £5.20

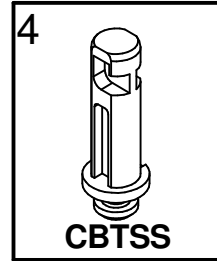

TAP SLOTTED STEM
PRICE: £2.80

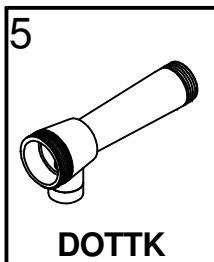

DRAW OFF TAP BODY
PRICE: £34.00



PLASTIC MOULDED FASCIA KIT
PRICE: £21.00

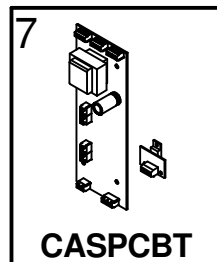

PRINTED CIRCUIT BOARD Inc. TRIAC
PRICE: £95.50

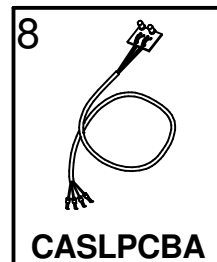

LIGHT PCB
PRICE: £10.40

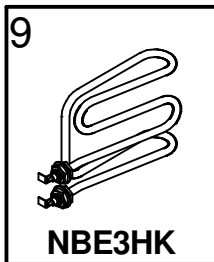

ELEMENT 3kW
PRICE: £35.00

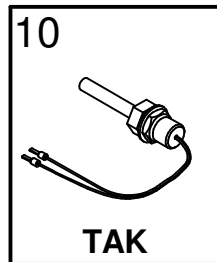

THERMISTOR ASSEMBLY KIT
PRICE: £26.20

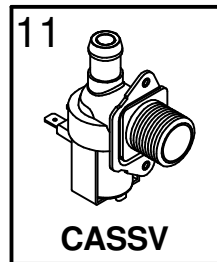

SOLENOID VALVE
PRICE: £17.40

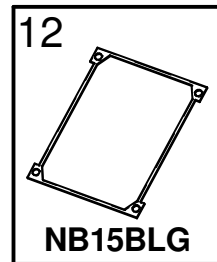

BODY LID GASKET
PRICE: £6.40

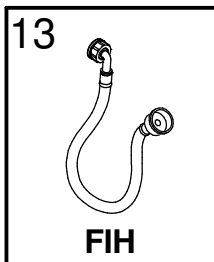

WATER INLET HOSE
PRICE: £10.60

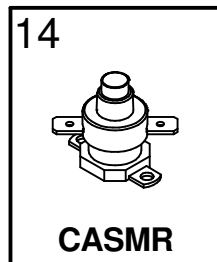

MANUAL RESET THERMAL CUTOUT
PRICE: £11.60

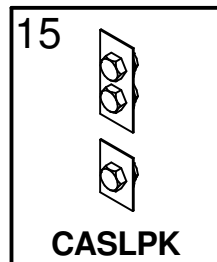

LEVEL PROBES KIT
PRICE: £27.00

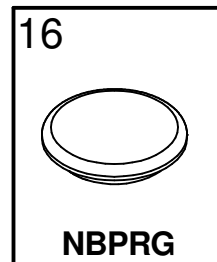

BODY LID GROMMET
£2.90

Cascade water boiler Exploded parts view

If parts required are not identified, please contact Calomax Limited

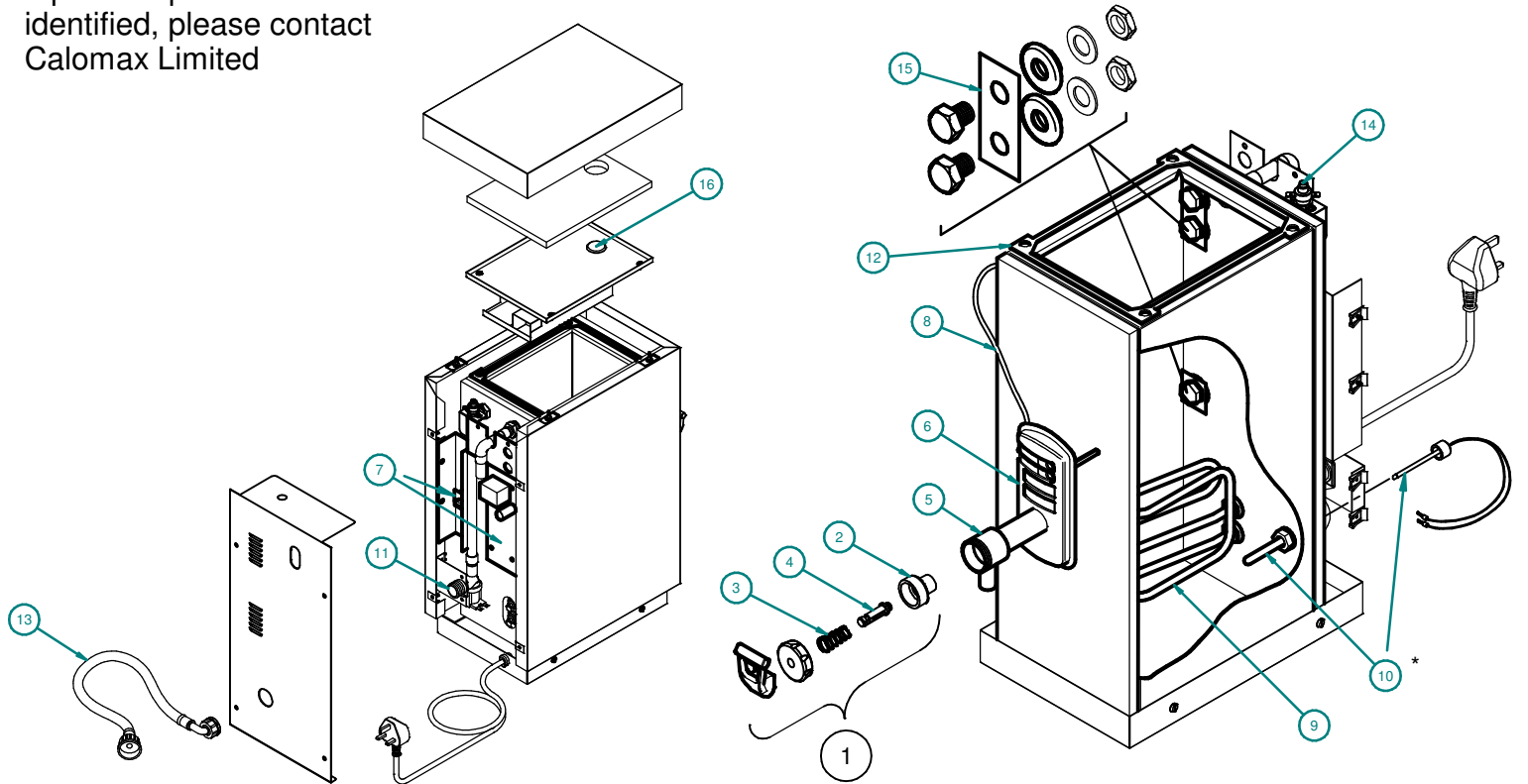

(Wrapper not shown for clarity)

* Includes nuts, washers, etc.