

Cascade6 TC water boiler.

Prices exclude packing, carriage & VAT

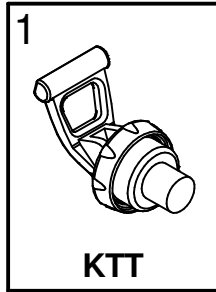

**KTT**  
TAP TOP  
ASSEMBLY  
£20.80

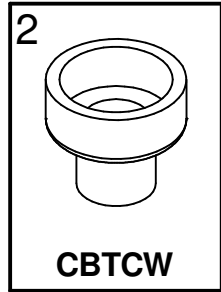

**CBTCW**  
TAP CUP WASHER  
£4.80

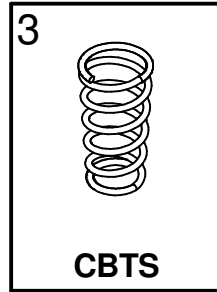

**CBTS**  
TAP SPRING  
£5.20

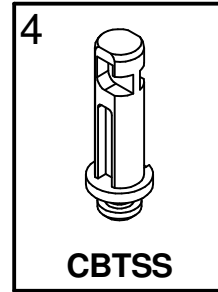

**CBTSS**  
TAP SLOTTED  
STEM  
£2.80

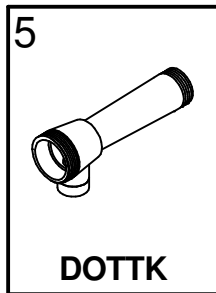

**DOTTK**  
DRAW OFF TAP  
BODY  
£34.00

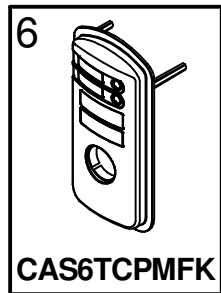

**CAS6TCPMFK**  
PLASTIC MOULDED  
FASCIA KIT  
£21.00

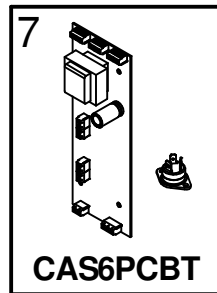

**CAS6PCBT**  
PRINTED CIRCUIT  
BOARD Inc. TRIAC  
£110.90

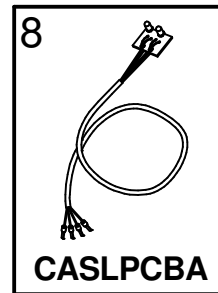

**CASLPCBA**  
LIGHT PCB  
£10.40

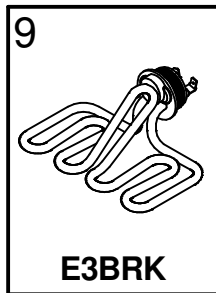

**E3BRK**  
ELEMENT 3kW  
£48.90

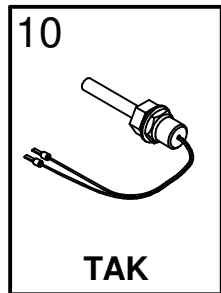

**TAK**  
THERMISTOR  
ASSEMBLY KIT  
£26.20

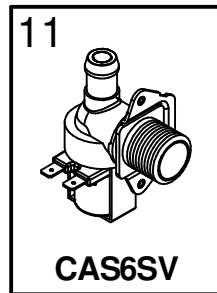

**CAS6SV**  
SOLENOID VALVE  
£17.40

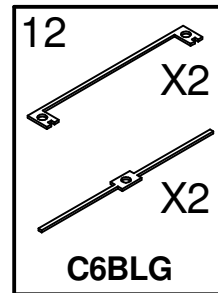

**C6BLG**  
BODY LID GASKET  
£9.40

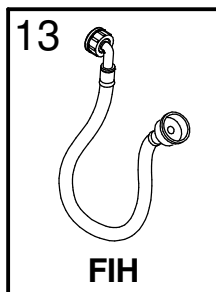

**FIH**  
WATER INLET  
HOSE  
£10.60

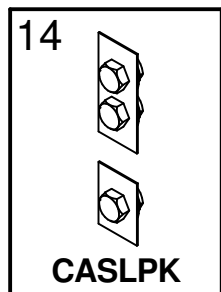

**CASLPK**  
LEVEL PROBES KIT  
£27.00

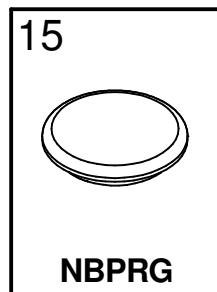

**NBPRG**  
BODY LID  
GROMMET  
£2.90

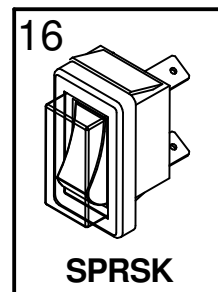

**SPRSK**  
SINGLE POLE  
ON/OFF SWITCH  
(INC. COVERS)  
£7.40

Cascade6 TC water boiler.  
Prices exclude packing, carriage & VAT

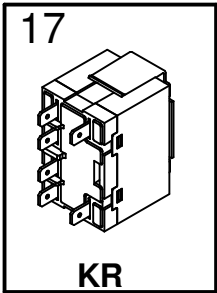

RELAY  
£15.20

If parts required are not identified, please contact Calomax Limited

### Exploded parts view

(To be read in conjunction with the spare parts list)

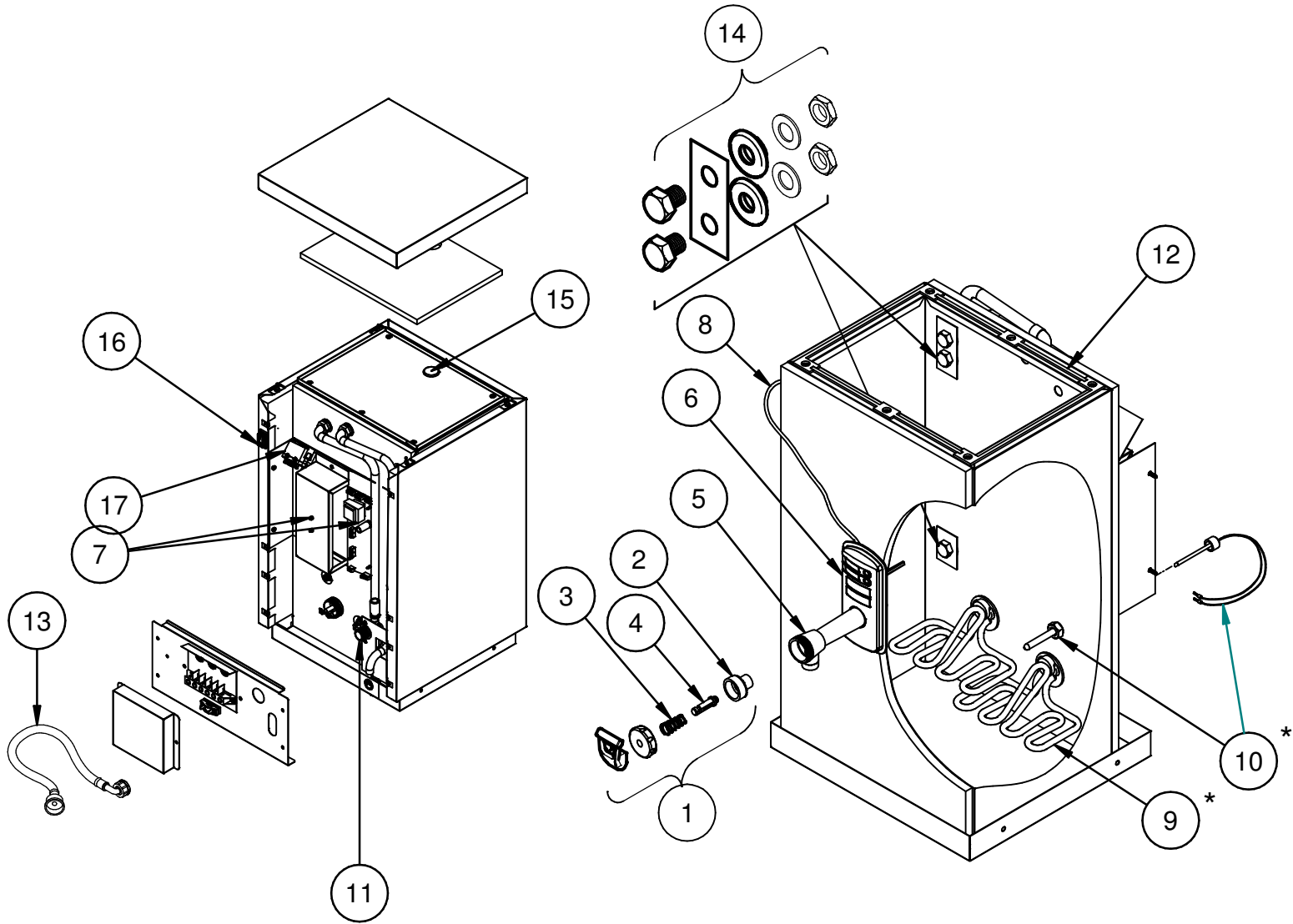

(Wrapper not shown for clarity)

\* Includes nuts, washers, etc.