

Compact water boilers. Prices exclude packing, carriage & VAT

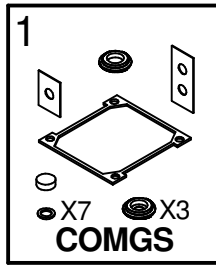

**COMGS**  
GASKET SET  
PRICE £15.80

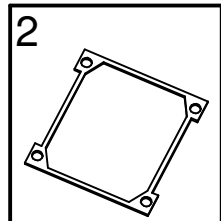

**NB5BLG**  
BODY LID GASKET  
PRICE £5.40

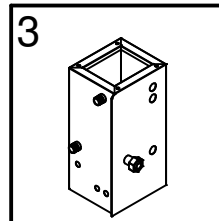

**COMBA**  
BODY  
P.O.A

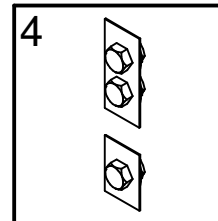

**CASLPK**  
LEVEL PROBES KIT  
PRICE £27.00

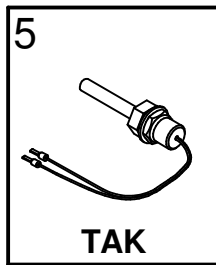

**TAK**  
THERMISTOR  
ASSEMBLY KIT  
PRICE £26.20



**NBE2HK**  
ELEMENT 2kW  
PRICE £35.00

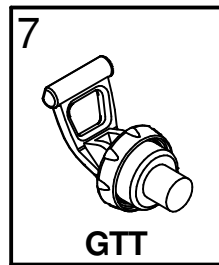

**GTT**  
TAP TOP  
ASSEMBLY  
PRICE £20.80

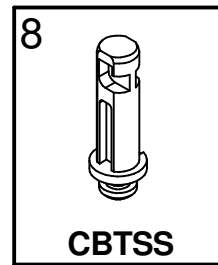

**CBTSS**  
TAP SLOTTED  
STEM  
PRICE £2.80

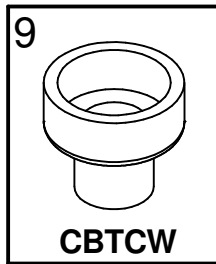

**CBTCW**  
TAP CUP WASHER  
PRICE £4.80

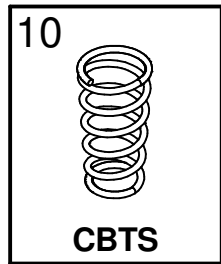

**CBTS**  
TAP SPRING  
PRICE £5.20

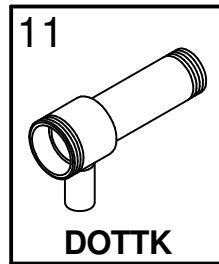

**DOTTK**  
DRAW OFF TAP  
BODY  
PRICE £34.00

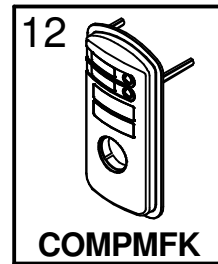

**COMPMFK**  
PLASTIC MOULDED  
FASCIA KIT  
PRICE £21.00

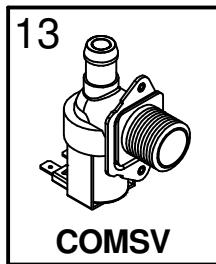

**COMSV**  
SOLENOID VALVE  
PRICE £17.40

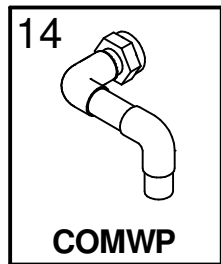

**COMWP**  
WATER PIPE  
PRICE £12.80

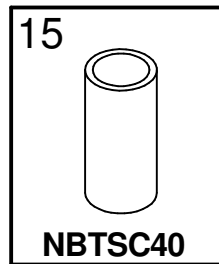

**NBTSC40**  
Ø15mm SILICONE  
TUBE CUT 40mm  
PRICE £1.20

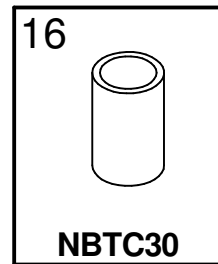

**NBTC30**  
Ø15mm SILICONE  
TUBE CUT 30mm  
PRICE £1.20

Compact water boilers. prices exclude packing, carriage & VAT

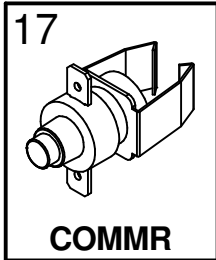

17

**COMMR**

MANUAL RESET  
THERMAL CUTOUT  
PRICE £13.80

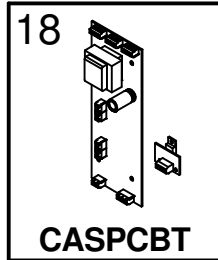

18

**CASPCBT**

PRINTED CIRCUIT  
BOARD Inc. TRIAC  
PRICE £95.50

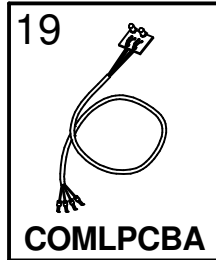

19

**COMLPCBA**

LIGHT PCB  
PRICE £10.40

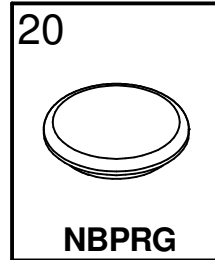

20

**NBPRG**

BODY LID  
GROMMET  
PRICE £2.90

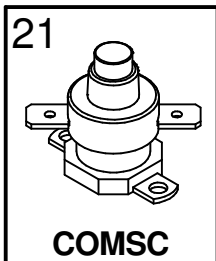

21

**COMSC**

MANUAL RESET  
ELEMENT CUTOUT  
PRICE £11.60

If parts required are not identified, please contact Calomax Limited

### Compact water boiler Exploded parts view

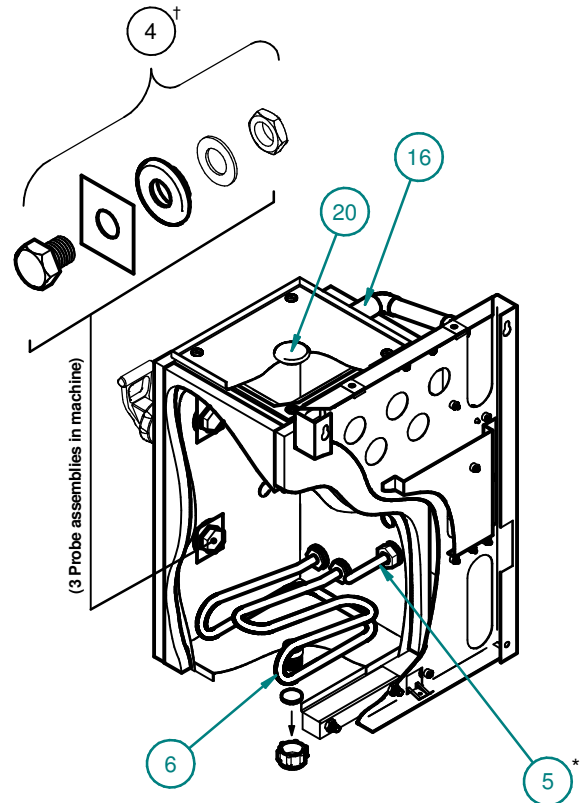
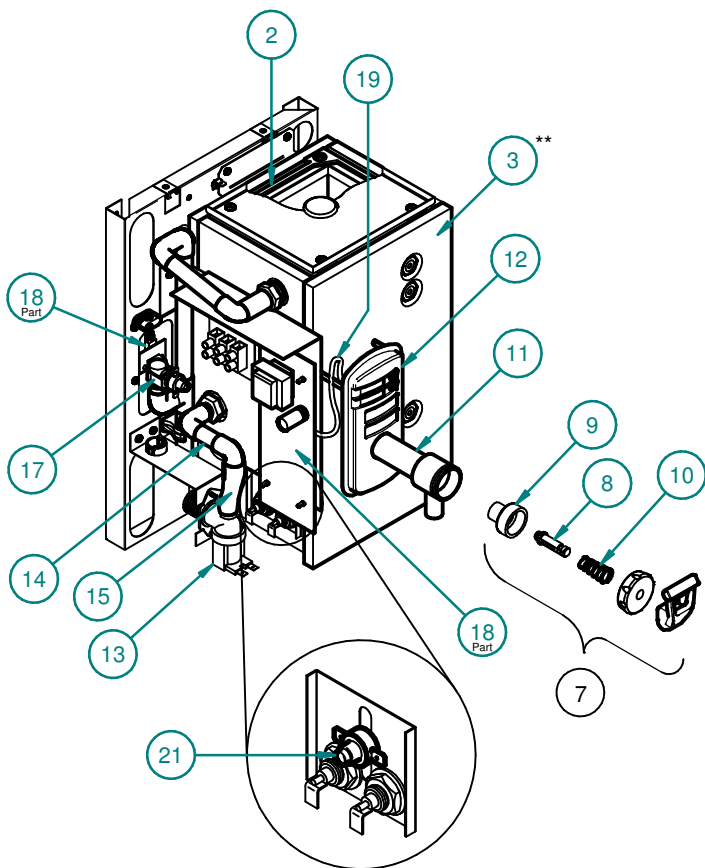

\* Includes nuts, washers, etc.  
\*\* Excludes insulation pieces, element, etc.  
† Set includes all three sensors, nuts, washers, etc.