

Kudos, Kudos3, Kudos/DF, Kudos3/DF models.
 Prices exclude packing, carriage & VAT

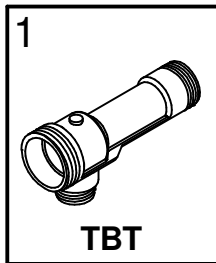

1
TBT
 DRAW OFF TAP
 BODY
 PRICE £36.00

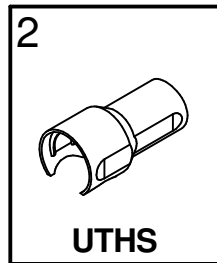

2
UTHS
 TAP BODY HEAT
 SHIELD
 PRICE £9.80

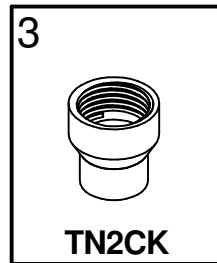

3
TN2CK
 SLOW-FILL NOZZLE
 PRICE £10.80

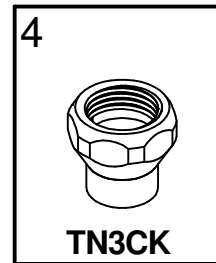

4
TN3CK
 FAST-FILL NOZZLE
 PRICE £11.40

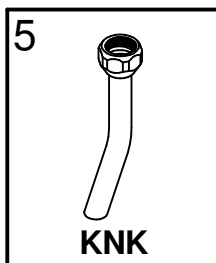

5
KNK
 EXTENDED FAST-FILL
 NOZZLE
 PRICE £17.20

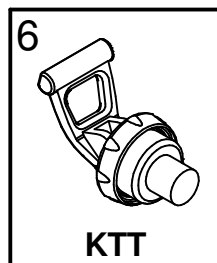

6
KTT
 TAP TOP ASSEMBLY
 PRICE £20.80



7
CBTCW
 TAP CUP WASHER
 PRICE £4.80

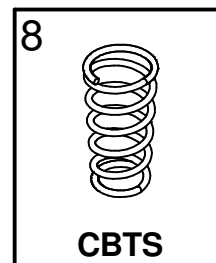

8
CBTS
 TAP SPRING
 PRICE £5.20

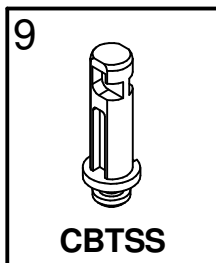

9
CBTSS
 TAP SLOTTED
 STEM
 PRICE £2.80



10
NBE3HK
 3kW ELEMENT
 PRICE £35.00

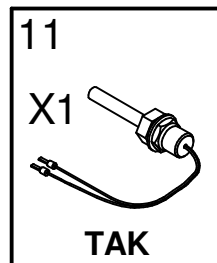

11
 X1
TAK
 THERMISTOR
 ASSEMBLY KIT
 PRICE £26.20

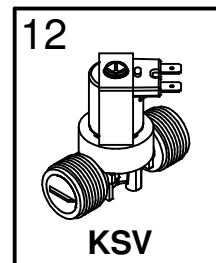

12
KSV
 SOLENOID VALVE
 PRICE £17.40

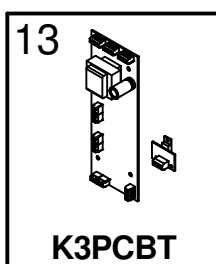

13
K3PCBT
 PRINTED CIRCUIT
 BOARD-3kW Inc.TRIAC
 PRICE £101.70

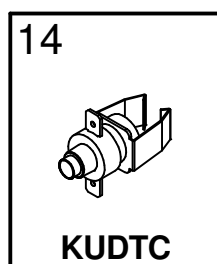

14
KUDTC
 MANUAL RESET
 THERMAL CUTOUT
 PRICE £13.80

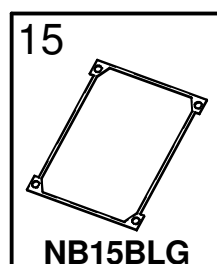

15
NB15BLG
 BODY LID GASKET
 PRICE £6.40

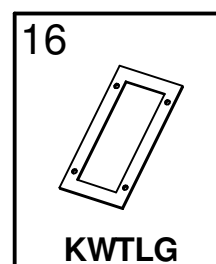

16
KWTLG
 WATER TANK
 GASKET
 PRICE £5.60

Kudos, Kudos3, Kudos/DF, Kudos3/DF models.
Prices exclude packing, carriage & VAT

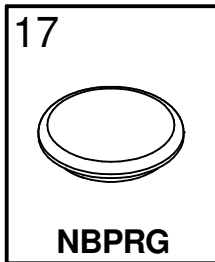

BODY LID
GROMMET
PRICE £2.90

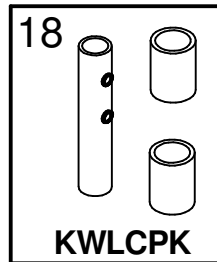

WATER LEVEL
CONTROL PIPE
PRICE £11.80

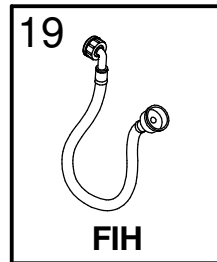

WATER INLET
HOSE
PRICE £10.60



PLASTIC FASCIA
FOR KUDOS
PRICE £21.00

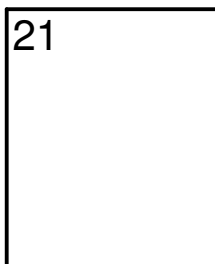

PLASTIC FASCIA FOR
DUAL FLOW BOILERS
PRICE £21.00

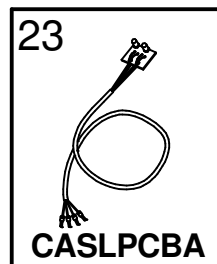

LIGHT PCB FOR
KUDOS & KUDOS3
PRICE £10.40

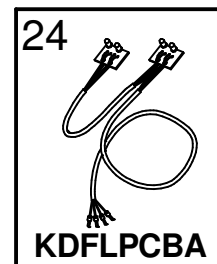

LIGHT PCB FOR DUAL
FLOW BOILERS
PRICE £25.90

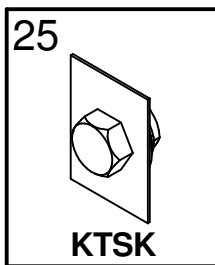

TANK SENSOR KIT
PRICE £9.40

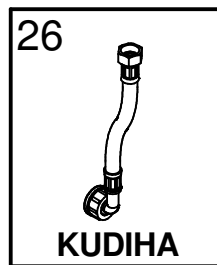

INTERNAL HOSE
ASSEMBLY (KUDOS)
PRICE £9.60

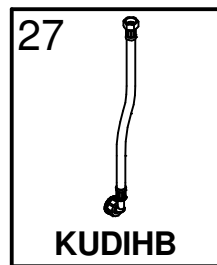

INTERNAL HOSE
ASSEMBLY (K3 & K3/DF)
PRICE £11.20

Exploded parts view for Kudos

If parts required are not identified, please contact Calomax Limited

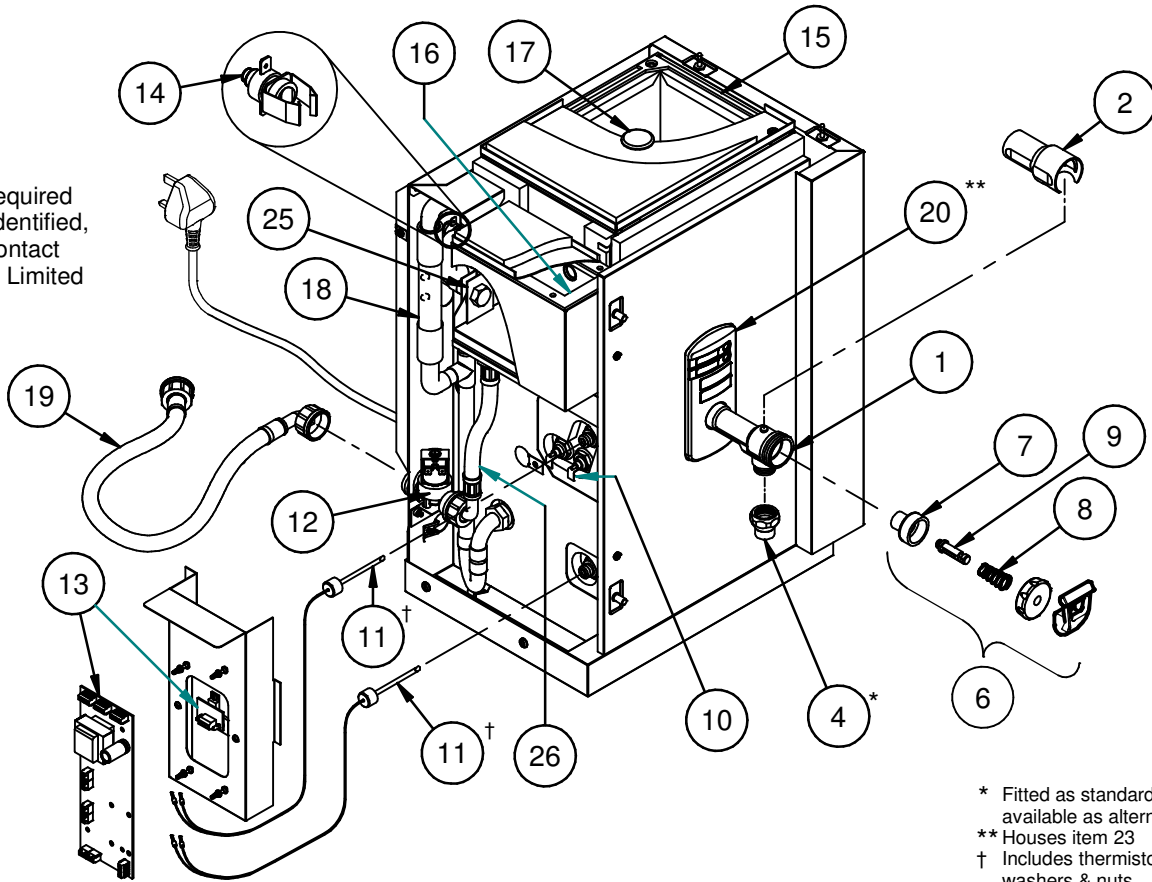

- * Fitted as standard. Item 3 available as alternative
- ** Houses item 23
- † Includes thermistor pocket, all washers & nuts

Exploded parts view Kudos3

If parts required are not identified, please contact Calomax Limited

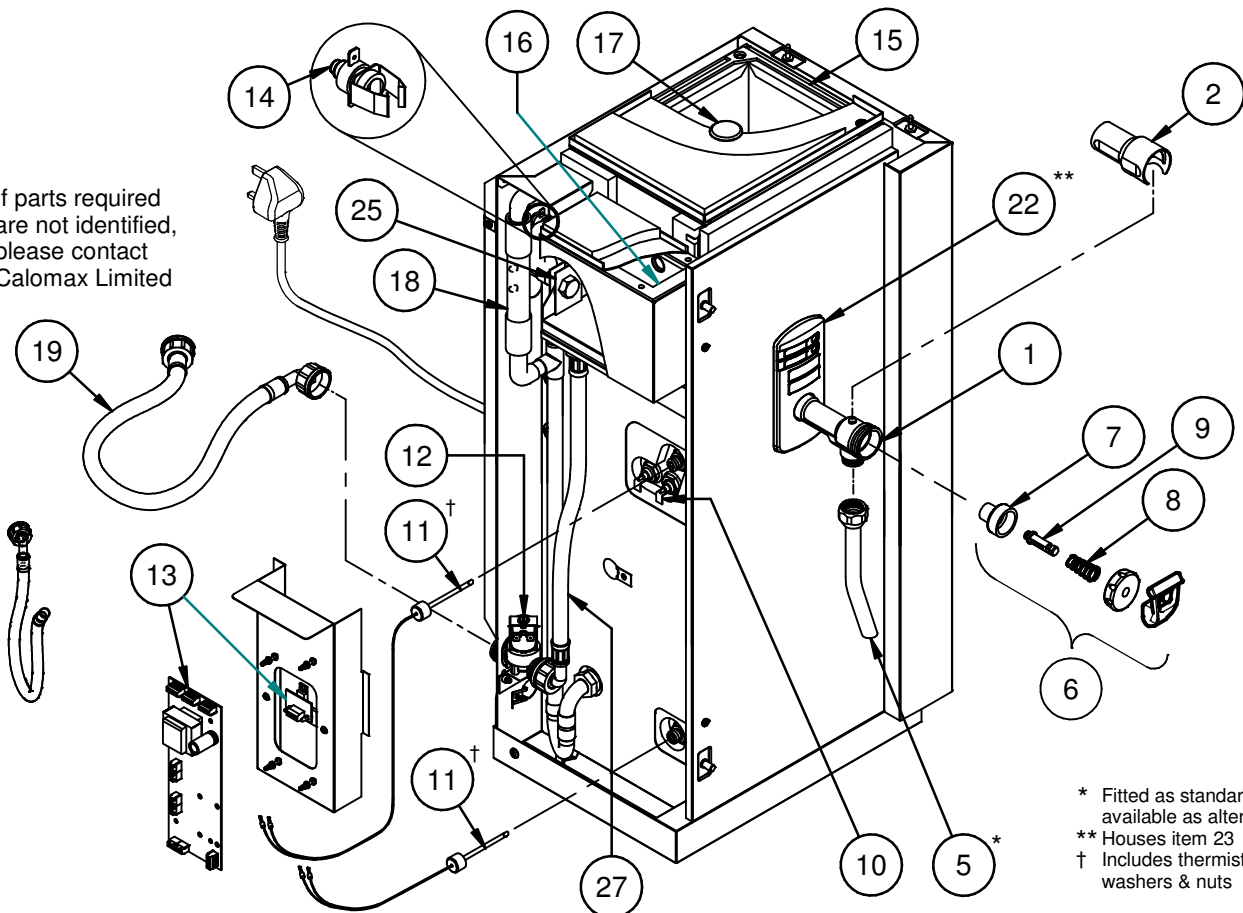

- * Fitted as standard. Items 3 or 4 available as alternatives
- ** Houses item 23
- † Includes thermistor pocket, all washers & nuts

Exploded parts view Kudos3 Dual Flow

If parts required are not identified, please contact Calomax Limited

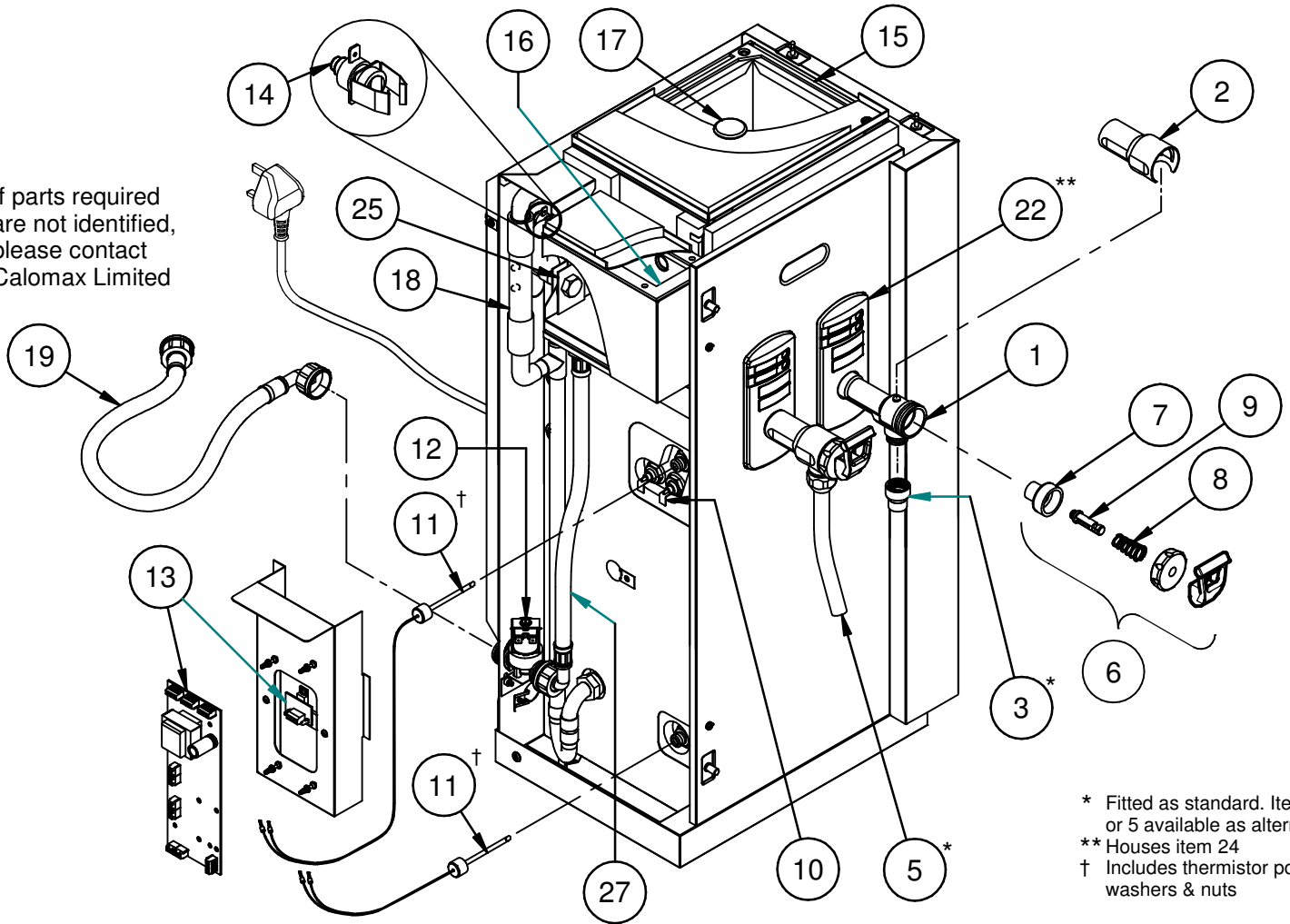

* Fitted as standard. Items 3, 4 or 5 available as alternatives
** Houses item 24
† Includes thermistor pocket, all washers & nuts