

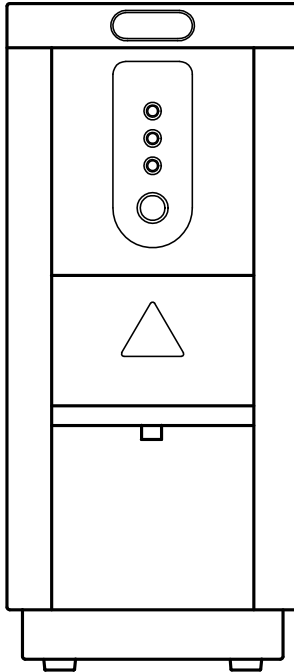

MODEL: QUEST  
(Incorporating On/Off switch)

## INSTALLATION, OPERATION AND SERVICING INSTRUCTIONS



Issue 1 8/12/09 DCR		Please read these instructions carefully before operating your boiler for the first time
---------------------------	--	--

Calomax Limited

Lupton Avenue, Leeds LS9 7DD

Tel. 0113 249 6681 Fax. 0113 235 0358

e-mail: [service@calomax.co.uk](mailto:service@calomax.co.uk)      [www.calomax.co.uk](http://www.calomax.co.uk)

CONTENTS	PAGE
INTRODUCTION	3
CHECK LIST	3
APPROVALS	3
CONSTRUCTION	4
<b>INSTALLATION</b>	4 - 6
LOCATION	4
COLD WATER INLET	5
DIMENSIONS AND WEIGHTS	5
VENT / OVERFLOW	6
ELECTRICAL CONNECTIONS	6
<b>USER INSTRUCTIONS</b>	6 - 7
SCALE	7
GENERAL OPERATION	12
GENERAL NOTES	8
ACCESSORIES	8 - 9
EXPLODED DIAGRAM	10-11
CLEANING	12
<b>SERVICE INSTRUCTIONS</b>	13-14-15
SPARE PARTS	16
WIRING DIAGRAM	17
TROUBLE SHOOTING	18
WARRANTY	19
PRODUCT SPECIFICATION	20

## INTRODUCTION

Thank you for purchasing a Calomax Quest water boiler. All our products are designed to give years of simple, reliable operation. To ensure this, it is important that the installation and subsequent servicing is carried out by a suitably qualified engineer in accordance with these instructions.

## CHECK LIST

Before commencing installation, check that the following parts have been supplied with the boiler:

1. WRAS approved flexible water inlet hose suitable for potable water.
2. BPDTK- plastic / stainless free-standing drip tray

## APPROVALS



This product conforms to the CE marking directive 93/68/EEC through compliance with the following standards:

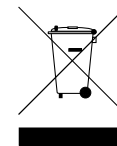

Electromagnetic Compatibility Directive  
Low Voltage Directive 73/23/EEC in accordance with:

BS EN 60335-2-63:1993

Compliance with these standards has been confirmed through testing by an independent NAMAS approved body



Calomax products have been tested and found to comply with the requirements of the Water Supply (Water Fittings) Regulations 1999 for England and Wales Water Bylaws 2000, Scotland and the Water Regulations Ireland.

## CONSTRUCTION

All metallic components of the machine, in direct contact with drinking water are manufactured from high quality 304 grade stainless steel, or non-ferrous materials, providing maximum resistance to corrosion.

## INSTALLATION

### LOCATION

The boiler must be installed in a location where access is restricted to operators that are suitably trained, or where untrained operators of the machine can be supervised by trained personnel.

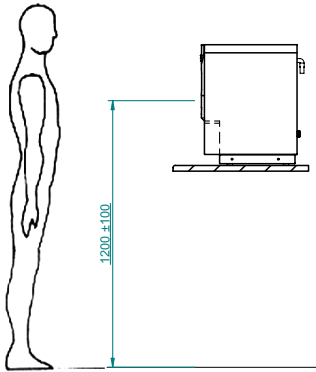

To comply with recommendations from the health and safety executive it is important that due consideration be given to safe operation of the controls of the boiler. The boiler should therefore be mounted in such a manner that the operator can stand directly facing the machine with the controls at a recommended height from the floor of 1200mm +/- 100mm. Consideration should also be given to the servicing requirements of the machine. The maximum and minimum

ambient operating conditions are 35 °C and 5 °C respectively. The appliance is not suitable for installation where a water jet could be used. Install the boiler on a surface suitable for near boiling temperatures and the working weight of the boiler. Allow adequate clearance for ventilation and for the easy removal of the outer casing lid and rear panel. Calomax Ltd recommend a minimum clearance of 50mm on all sides of the boiler. A suitably qualified engineer must install this unit. Plumbing and electrical installation work is involved.

## COLD WATER INLET

To comply with the U.K. Water Supply Regulation a single check-valve must be fitted to the supply. BEFORE CONNECTING, THE SUPPLY PIPE MUST BE THOROUGHLY FLUSHED OUT TO ENSURE THAT FOREIGN MATTER DOES NOT BLOCK OR ENTER THE SOLENOID VALVE

The boiler must be connected to a potable water supply using the food grade hose provided, in a manner which complies with appropriate local water regulations. The hose should be connected to a ½” (15mm) drinking water supply via an appropriate isolating valve. The supply must provide a constant pressure of between 20 KPa and 1000 KPa (0.2 to 10 Bar). If the water supply contains excessive solids in suspension it is recommended that a fine mesh “in-line” water filter is fitted in the pipe work after the stop cock. Failures due to scale and sediment are not covered by the warranty.

### DIMENSIONS AND WEIGHTS

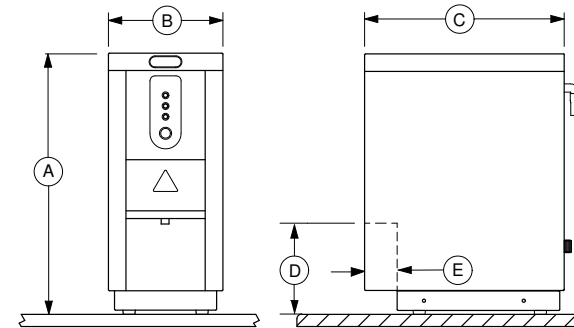

MODEL		A	B	C	D	E	DRY WEIGHT	WORKING WEIGHT
Quest	mm	546	240	410	201	65	12 KG	29 KG

## VENT & OVERFLOW

The vent / overflow pipe must be extended and laid with a **continuous fall**, discharging to a safe and visible point. The pipe should not be directly connected to a closed waste, as taste problems may occur and should never be allowed to become blocked or restricted. One way this could be connected is via a tundish arrangement. 15mm copper or 'Speedfit' pipe should be used. If the machine is operated without the overflow pipe being extended as advised, any subsequent damage incurred will be the responsibility of the installer.

## ELECTRICAL CONNECTIONS

The boiler is supplied with a fitted plug and lead and should be plugged into a 220 - 240v 13A electrical socket, capable of carrying a load of 3kW. The installation of a residual current device (RCD) having a rated residual operating current not exceeding 30 mA is advisable.

## USER INSTRUCTIONS



During normal operation some external parts will become hot. Care must be taken to avoid a burn or scald injury.

### Commissioning

1. Turn water supply on
2. Turn electrical supply on. Ensure that the On / Off switch (located at the rear) is in the On position

#### **On initial switch-on only**

After a few seconds delay for the electronics to charge up, the boiler will begin filling with water and the 'Ready' light and push button will flash to indicate 'Wait'. At this point the push button is disabled. When water reaches the low level sensor (element covered) the element will be energised as well as the solenoid. When the normal operating level is reached the solenoid will turn off and the element will remain on until full operating temperature is reached.

The push button will stop flashing and show solid colour when the boiler is up to full temperature and the button will be enabled. At this point the 'Ready' light will stop flashing and show solid colour and the 'Full' light will also be illuminated.

Page 6

### ***On subsequent operation of the boiler***

The boiler will fill and heat in cycles. It will allow only a limited amount of water to enter the unit at any one time and then switch off the solenoid and energise the element.

### **Subsequent Use**

After the boiler has finished the commissioning cycle and water is drawn from the dispense valve, water will be replaced in short cycles (small amount of water and then heat). The solenoid and element will never be on at the same time unless the boiler is switched off and on again (re-setting commission mode). In normal use the boiler will always be at operating temperature indicated by the 'Ready' light and push button showing a solid (not flashing) colour. When the boiler is full and ready the 'Full' light will also be illuminated.

Note:

When the green service indicator light on the front of the boiler is showing solid colour, the machine has been starved of water for in excess of 20 minutes and the solenoid valve has been disabled to prevent damage to the solenoid coil through overheat. To re-energise the solenoid, the unit must be disconnected from the electrical supply and then switched back on, after first reinstating the water supply.

## SCALE

To ensure continuous, reliable operation, the boiler should be regularly de-scaled by a suitably qualified engineer. Suitable chemical de-scalants must only be used if the manufacturer's recommendations are strictly adhered to. This is to prevent health and safety issues, taste problems and potential damage to the appliance. Misuse of such chemicals is not covered by the product warranty.

The Quest boiler benefits from an integral scale inhibitor. **This is not** a scale eliminator and its effects will differ according to the water quality in your area. The production of scale is a natural phenomenon and some de-scaling may be required within the first 12 months. This is not covered under the product warranty as it is not a fault. If the water supply contains excessive solids in suspension it is recommended that a fine mesh 'in-line' water filter is fitted in the pipe work after the stop cock.

Page 7

# Accessories

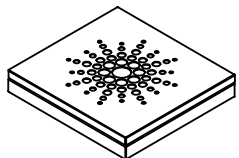

## Worktop-mounting Stainless Steel drip tray

Ref. HSSDTK (freestanding)  
HSSDTWDK (with drain outlet)

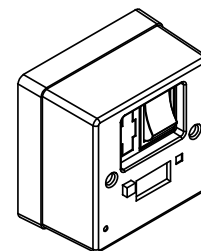

## Fused spur time switch

Ref. 7DFST  
Max 3kW

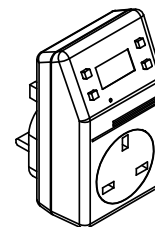

## Plug-in time switch

Ref. 7DPIT  
Max 3kW

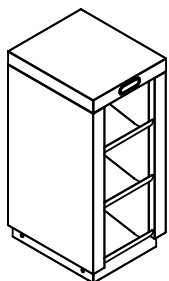

## Ingredient caddy

Ref. IC3 (3 bay) - *as shown*  
IC4 (4 bay)

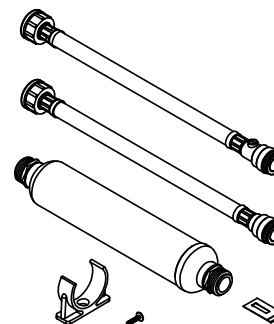

## Water filter kit

(To reduce taste & odour problems)  
Ref. 10TOSCK

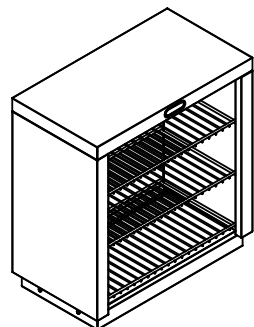

## Shelf unit

Ref. SHU

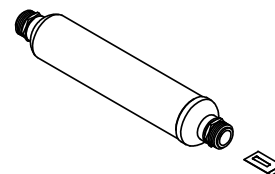

## Ref. 10TOSC

(Filter & timestrip replacement for  
kit shown above)

For more information visit our website at [www.calomax.co.uk](http://www.calomax.co.uk) or call 0113 249 6681

# Exploded parts view for Quest boiler

(To be read in conjunction with the spare parts list)

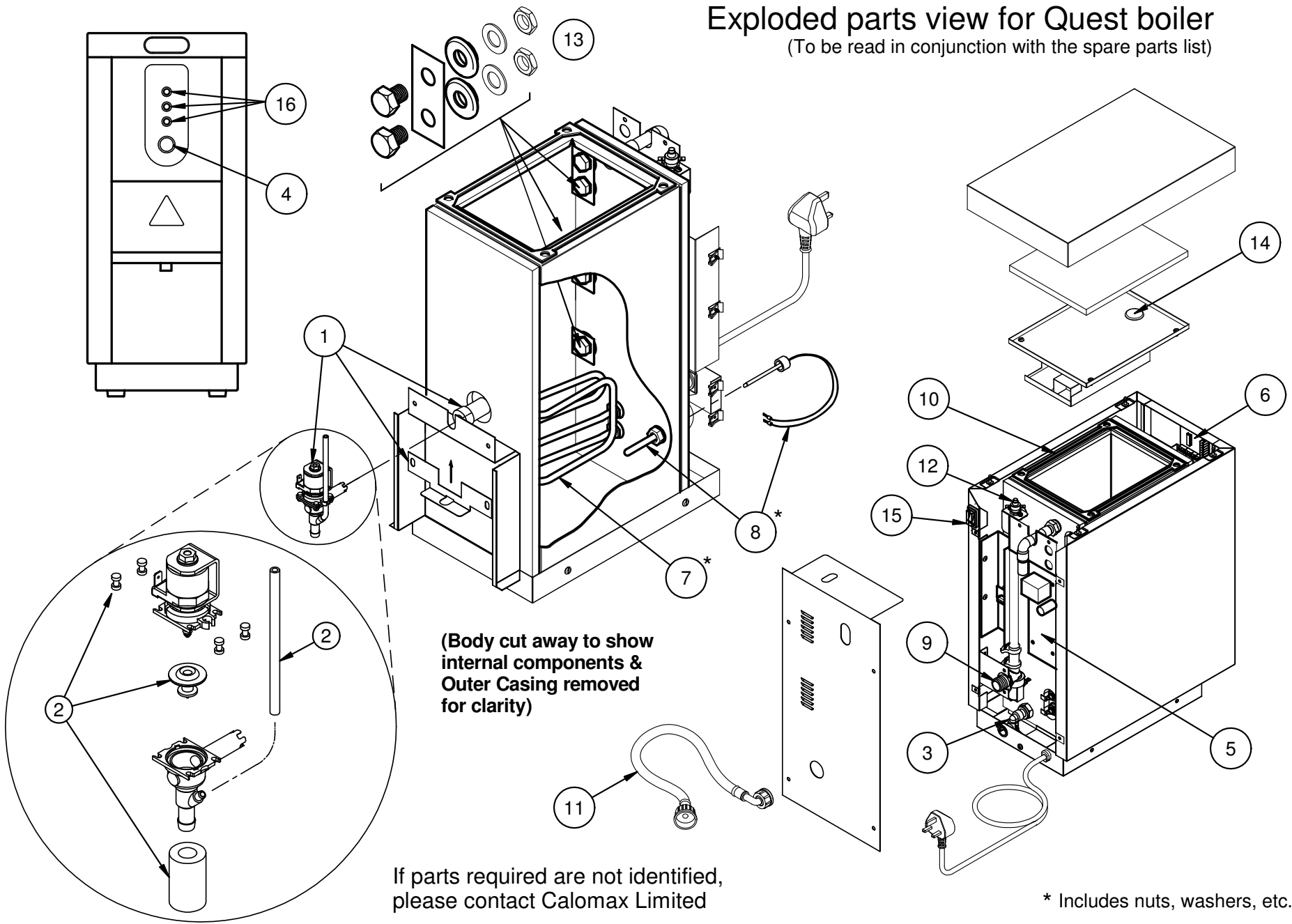

## GENERAL OPERATION

- Hold a cup below the dispense valve or place large vessels on the drip tray. Care must be taken to avoid injury through splashing or over-filling.
- To begin filling, press the dispense button and water will flow from the outlet nozzle.
- To stop filling, release the dispense button.

NEVER PASS YOUR HAND BENEATH THE NOZZLE.

## GENERAL NOTES

- Please retain these instructions for future reference
- Ensure that a suitable drip tray (such as the one supplied) is positioned below the dispense valve. This will help keep the surrounding work surfaces and floor free from drips or splashes. Various options are available and are outlined on the Accessories page of this booklet.
- All de-scaling and servicing must be performed by a suitably qualified engineer.

## CLEANING



Avoid using any abrasive materials. Wiping the outer casing with a damp cloth should be sufficient. Some stainless steel cleaning products may not be suitable for plastic and must not come in contact with the plastic fascia. Always disconnect the electrical supply before cleaning.

NEVER USE A SPRAY JET OR ANY OTHER METHOD WHICH COULD CAUSE WATER TO ENTER THE ELECTRICAL CHAMBER.

## SERVICE INSTRUCTIONS

When the green service indicator light on the front of the boiler is showing solid colour, the machine has been starved of water for in excess of 20 minutes and the solenoid valve has been disabled to prevent damage to the solenoid coil through overheat. To re-energise the solenoid, the unit must be disconnected from the electrical supply and then switched back on, after first reinstating the water supply.

If the unit requires servicing the service indicator will flash a sequence of light pulses. A 2x or 3x-light pulse generally indicates that the low or normal level probes require de-scaling.

A 4x-light pulse means the water level has reached the high level sensor and the likelihood is that the normal level sensor requires de-scaling, or the machine has over-filled due to debris trapped in the solenoid valve. The debris can be removed by drawing plenty of water from the dispense valve, causing the solenoid valve to operate and flush out the obstruction. The machine will reset itself once the problem has cleared. If this does not rectify the problem, turn off the water supply and remove the flexible hose to check for debris in the valve's filter. The unit can be used normally while the service indicator is flashing a 4x pulse. For further assistance, contact our service department on 0113 249 6681, e-mail [service@calomax.co.uk](mailto:service@calomax.co.uk) or find a local service engineer at [www.calomax.co.uk](http://www.calomax.co.uk)

**Once the outer casing is removed, access to the Service Area has been gained. This access must be restricted to persons having knowledge and practical experience of the appliance, in particular as far as safety and hygiene are concerned.**

### De-scale

To gain access to internal components, the body lid must be removed. The lid incorporates a condenser mechanism which must be fitted the correct way round. The lid is labelled accordingly. To remove the lid, break the lid gasket seal and pull the lid forward and up, to the front of the machine before lifting it clear of the body.

**Note:** Whenever the body lid has been removed from the boiler a new lid gasket may be required to ensure a steam-tight joint. Damage to the unit caused by a poor lid seal is not covered by warranty.

Scale deposits should be removed from all internal surfaces, particularly the heating element, thermistor and level sensors by gently tapping or scraping. If the deposits are soft, use a nylon pad and flush out. Abrasive cleaning materials containing scouring powders and detergents must not be used, such materials can cause taste problems.

Suitable chemical de-scalants must only be used in accordance with the manufacturer's recommendations. This will prevent health and safety issues, taste problems and potential damage to the appliance. All trace of these chemicals must be removed from the appliance before re-commissioning the unit. Misuse of such chemicals is not covered by the product warranty.

**IMPORTANT Before re-commissioning the boiler it is important that all scale and moisture is removed from the level sensor insulating gaskets, to avoid a false signal being transmitted through the scale to the boiler body. Failure to remove this scale and/or moisture could cause the sensor to indicate to the PCB that water is covering the element, whether or not water is present. In this situation the PCB could energise the element causing failure. If in doubt, protect the element by hand filling with water to the level of the draw-off tap before switching on the electrical supply to the boiler.**

### General function

The printed circuit board (PCB) controls the heating and filling functions of the boiler by monitoring the thermistor and level sensors. The PCB also controls the external light unit to indicate the current state of the boiler. Red and yellow LED'S on the circuit board indicate whether the PCB has energised the element or solenoid respectively.

The auxiliary PCB controls the dispense valve and push button functions.

Should an element fail and need to be replaced, it may be necessary to replace the lid gasket to ensure a reliable steam-tight seal. **Note: the element has a permanent 'Live' feed, and the 'Neutral' is switched.**

### Printed Circuit Board replacement (PCB)

In the event of a PCB failing and a replacement being required, full instructions will be supplied. It is important to note however, that the Triac PCB must be securely mounted against the copper heat-sink to ensure reliable heat dissipation. Heat transfer compound is also supplied with all replacement circuit boards.

### Adjusting the Water Temperature Set Point

The temperature potentiometer (Pot) is pre-set at Calomax and will only require adjustment in exceptional circumstances. Contact Calomax for advice.

Water boils at different temperatures depending on barometric pressure. The temperature should not be tuned higher than 98°C, or over boiling may occur during low barometric pressure conditions, causing the unit to trip the overheat cut-out device.

### On / Off Switch

The On / Off switch is positioned at the rear of the machine. When in the off position the unit will cease to function & the light on the fascia will go out.

NOTE: This switch must not be used to isolate the electrical supply for servicing / maintenance. When maintaining / servicing the unit the power cord must be removed from the mains supply.

## SPARE PARTS

(Refer to centre pages for location).

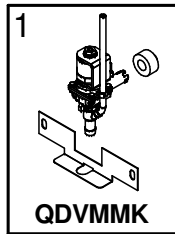

**1**  
**QDVMMK**  
MULLER DISPENSE VALVE & GROMMET

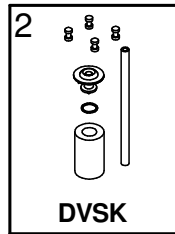

**2**  
**DVSK**  
DISPENSE VALVE SERVICE KIT

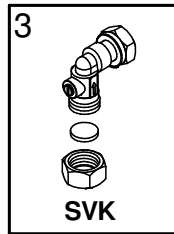

**3**  
**SVK**  
SERVICE VALVE KIT

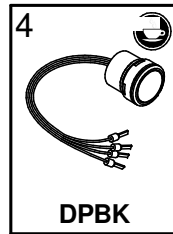

**4**  
**DPBK**  
WATER DISPENSE PUSH BUTTON Inc. FITTING TOOL

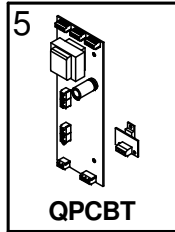

**5**  
**QPCBT**  
MAIN PRINTED CIRCUIT BOARD Inc. TRIAC

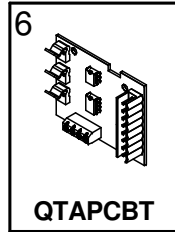

**6**  
**QTAPCBT**  
AUXILIARY PCB

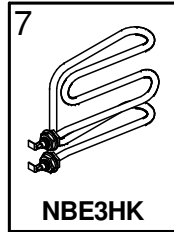

**7**  
**NBE3HK**  
ELEMENT 3kW

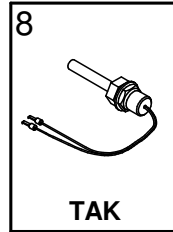

**8**  
**TAK**  
THERMISTOR ASSEMBLY KIT

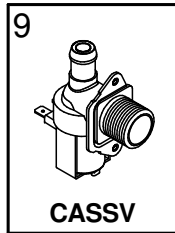

**9**  
**CASSV**  
SOLENOID VALVE

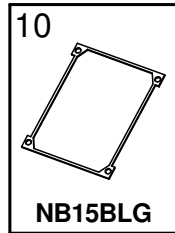

**10**  
**NB15BLG**  
BODY LID GASKET

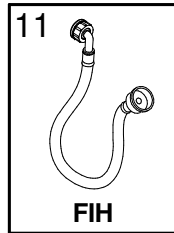

**11**  
**FIH**  
WATER INLET HOSE

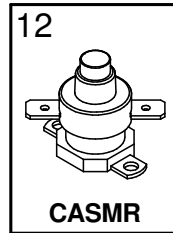

**12**  
**CASMR**  
MANUAL RESET THERMAL CUTOUT

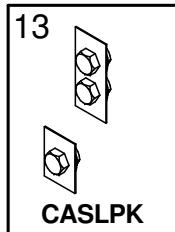

**13**  
**CASLPK**  
LEVEL PROBES KIT

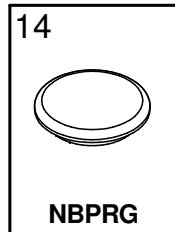

**14**  
**NBPRG**  
BODY LID GROMMET

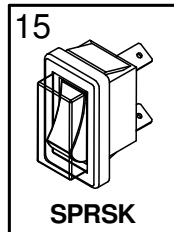

**15**  
**SPRSK**  
SINGLE POLE ON/OFF SWITCH (INC. COVERS)

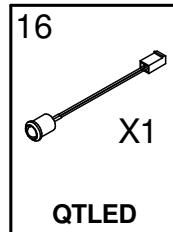

**16**  
**QTLED**  
PANEL-MOUNTING LED INDICATOR

Spare parts are usually available ex-stock.  
Please quote Model & Serial Number.

## Wiring Schematic for Calomax Quest Water Boiler

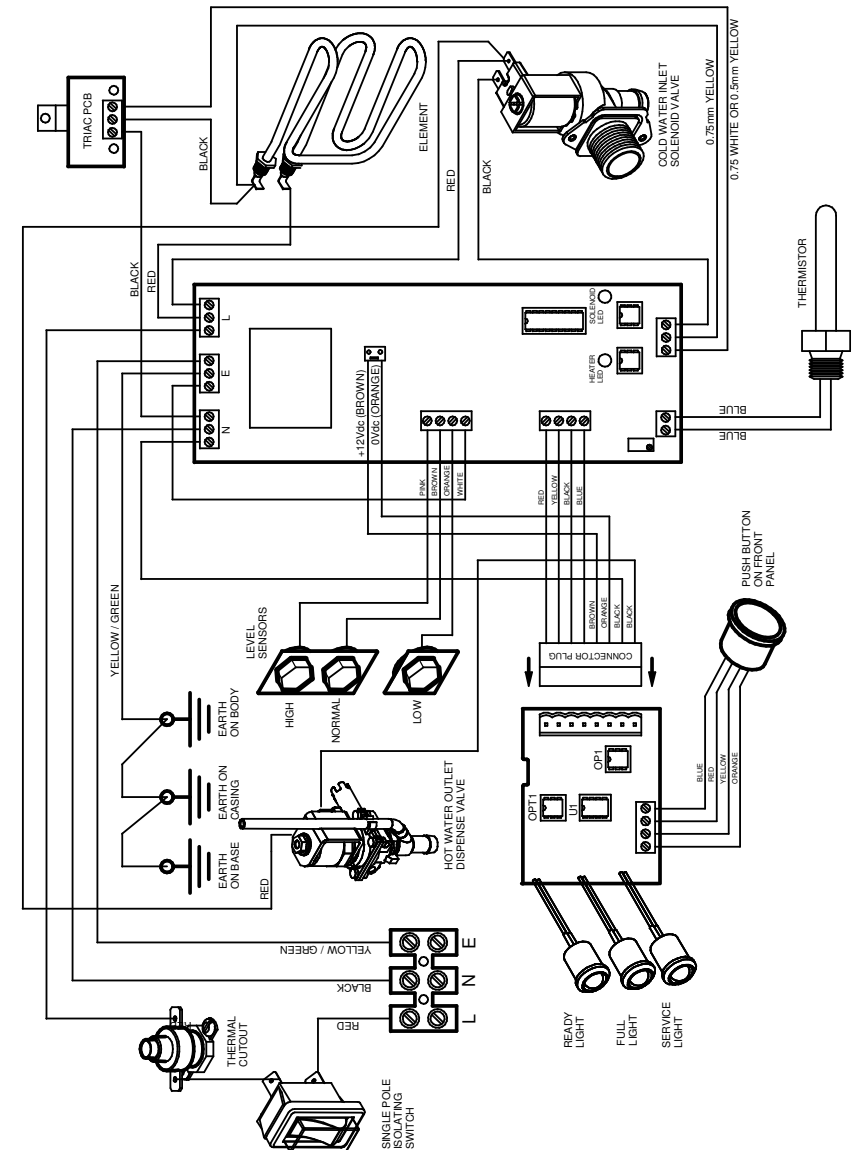

## BASIC TROUBLE SHOOTING

Symptoms	Possible Cause	Remedy
No lights on front of unit	On / Off switch in Off position Thermal cut-out tripped	Switch to On position Reset and check for faults (i.e. scale on thermistor)
No boiling water available	Normal level sensor holding a signal Thermal cut-out tripped (no lights on fascia) On / Off switch in Off position Element failed	De-scale Reset and check for faults (i.e. scale on thermistor) Switch to On position Replace element
Thermal cut-out trips regularly	Excessive internal scale. (See 'De-Scale' ) Faulty wiring to thermistors / faulty thermistors Temperature controller needs adjusting Element failed to earth Defective Main Printed Circuit Board & / or Triac PCB	De-scale the boiler (Particularly thermistor) Repair / replace as required Lower operating temperature Replace element Replace Circuit Board & Triac (sold as a matched pair)
Overflows	Dirt in solenoid valve. Level sensors require de-scaling or replacing Main Printed Circuit Board faulty	Clean solenoid filter / or replace solenoid, "work the boiler" - see Service Instructions De-scale / replace sensors Replace Main Printed Circuit Board

## WARRANTY GUARANTEE (UK Mainland customers only)

Calomax have manufactured water boilers in the UK for over 50 years. We are proud of our products and the back-up service we provide.

Properly maintained and serviced, a Calomax boiler should last many years and we have no hesitation in providing a full 12 months (mainland U.K.) parts and labour warranty for all models. Please complete and return the enclosed product registration form as soon as possible to activate this, or register online at:

[www.calomax.co.uk](http://www.calomax.co.uk) .

In addition, the Clipper, Kudos and Quantum models carry an additional 12 month back to base warranty.

Some factors are beyond our control and would invalidate the warranty offered. These include:

- Incorrect installation
- High / Low water pressure
- Incorrect voltage supply
- Accidental damage
- Limescale build-up

The last item can be a particular problem for water dispensing equipment in hard-water areas. All hot water equipment should be serviced and de-scaled by approved organisations on a regular basis to avoid a damaging build-up of limescale.

Although our boilers incorporate scale-inhibitor technology, we recommend that a taste, odour and scale filter should be fitted where appropriate.

Please visit our website [www.calomax.co.uk](http://www.calomax.co.uk) for details of our Service Partner Network and the range of filters and accessories available.

PLEASE ENTER SERIAL NUMBER FOR FUTURE REFERENCE

Model	QUEST
Serial Number	
Draw off Capacity	9 Litres
Heat-up Time (first switch-on) 9 Litre capacity	45 Minutes
Average flow rate from dispense valve	2.8 Litres / Minute
Voltage	220 - 240 V ac 50-60 Hz
Power rating	3kW (MAX)

Note: All measurements are approximate.

**PLEASE CONTACT OUR SERVICE DEPARTMENT FOR ASSISTANCE**

Calomax Limited, Lupton Avenue, Leeds LS9 7DD

Tel: 0113 249 6681

Fax: 0113 235 0358

e-mail: [service@calomax.co.uk](mailto:service@calomax.co.uk)