

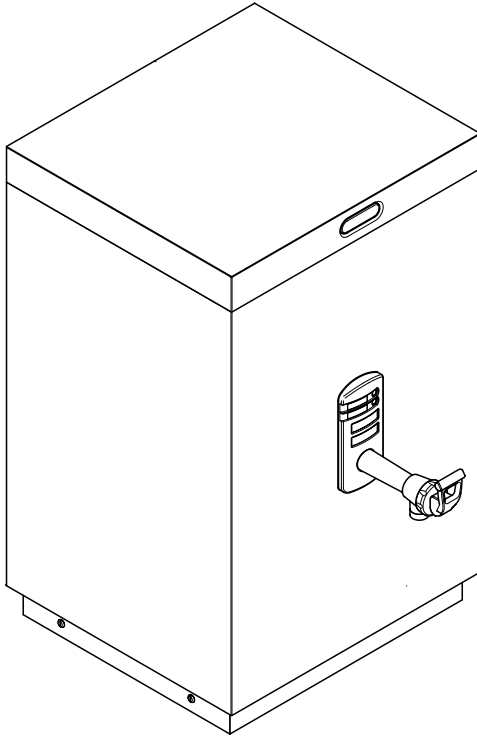

MODEL: CASCADE-6A  
With Power Switch

## INSTALLATION, OPERATION AND SERVICING INSTRUCTIONS



Issue 1 21/1/09 DCR	A warning triangle icon with a thick black border and a large exclamation mark inside.	Please read these instructions carefully before operating your boiler for the first time
---------------------------	--	--

Calomax Limited

Lupton Avenue, Leeds LS9 7DD

Tel. 0113 249 6681 Fax. 0113 235 0358

E-mail: [service@calomax.co.uk](mailto:service@calomax.co.uk)

[www.calomax.co.uk](http://www.calomax.co.uk)

## CONTENTS

INTRODUCTION	PAGE 3
CHECK LIST	3
APPROVALS	3
CONSTRUCTION	4
<b>INSTALLATION</b>	4
LOCATION	4
COLD WATER INLET	5
DIMENSIONS AND WEIGHTS	5
VENT / OVERFLOW	6
ELECTRICAL CONNECTIONS	6
<b>USER INSTRUCTIONS</b>	6
SCALE	7
GENERAL OPERATION	8
GENERAL NOTES	8
CLEANING	8
SPARE PARTS	9/10
EXPLODED DIAGRAM	12/13
<b>SERVICE INSTRUCTIONS</b>	11
ACCESSORIES	16/17
WIRING DIAGRAM	18
TROUBLE SHOOTING	19
WARRANTY	20
PRODUCT SPECIFICATION	24

## INTRODUCTION

Thank you for purchasing a Calomax Cascade-6A boiler. All our products are designed to give years of simple, reliable operation. To ensure this, it is important that the installation and subsequent servicing is carried out by a suitably qualified engineer in accordance with these instructions.

For assistance in finding a suitable engineer in your area, visit our web site [www.calomax.co.uk](http://www.calomax.co.uk) or contact our service department on 0113 249 6681 or e-mail: [service@calomax.co.uk](mailto:service@calomax.co.uk)

## CHECK LIST

Before commencing installation, check that the following parts have been supplied with the boiler:

1. WRAS approved food grade water inlet hose
2. Status label
3. Free-standing drip tray

## APPROVALS



This product conforms to the CE marking directive 93/68/EEC through compliance with the following standards:



Electromagnetic Compatibility Directive  
Low Voltage Directive 73/23/EEC in accordance with:

BS EN 60335-2-75:2004

Compliance with these standards has been confirmed through testing by an independent NAMAS approved body



Calomax products have been tested and found to comply with the requirements of the Water Supply (Water Fittings) Regulations 1999 for England and Wales Water Bylaws 2000, Scotland and the Water Regulations Ireland.

## CONSTRUCTION

All metallic components of the machine, in direct contact with drinking water are manufactured from high quality 304 grade stainless steel, or non ferrous materials, providing maximum resistance to corrosion.

## INSTALLATION

### LOCATION

The boiler must be installed in a location where access is restricted to operators that are suitably trained, or where untrained operators of the machine can be supervised by trained personnel.

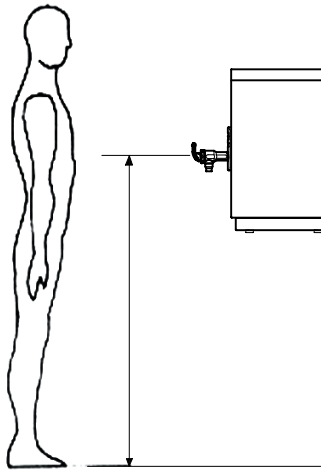

To comply with recommendations from the health and safety executive it is important that due consideration be given to safe operation of the controls of the boiler. The boiler should therefore be mounted in such a manner that the operator can stand directly facing the machine with the controls at a recommended height from the floor to the draw-off tap handle of 1200mm +/- 100mm. Consideration should also be given to the servicing requirements of the machine. The maximum and

minimum ambient operating conditions are 35 °C and 5 °C respectively. The appliance is not suitable for installation where a water jet could be used. Install the boiler in a position having adequate ventilation, on a level and firm surface suitable for near boiling temperatures and the working weight of the boiler. Allow clearance for the easy removal of the outer casing lid and rear panel. A suitably qualified engineer must install this unit. Plumbing and electrical installation work is involved.

## COLD WATER INLET

To comply with the U.K. Water Supply Regulation a single check-valve must be fitted to the supply. BEFORE CONNECTING, THE SUPPLY PIPE MUST BE THOROUGHLY FLUSHED OUT TO ENSURE THAT FOREIGN MATTER DOES NOT BLOCK OR ENTER THE SOLENOID VALVE

The boiler must be connected to a potable water supply using the food grade hose provided, in a manner which complies with UK water regulations. The hose should be connected to a ½” (15mm) drinking water supply via an appropriate isolating valve. The supply must provide a constant pressure of between 20 KPa and 1000 KPa (0.2 to 10 Bar), via an isolating stop cock fitted near the boiler.

If the water supply contains excessive solids in suspension it is recommended that a fine mesh “in line” water filter is fitted in the pipe work after the stop cock. Failures due to scale and sediment are not covered by the warranty.

### DIMENSIONS AND WEIGHTS

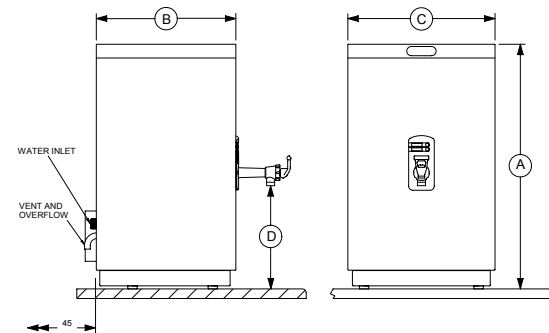

MODEL		A	B	C	D	DRY WEIGHT	WORKING WEIGHT
Cascade-6A	mm	640	365	385	270	16.5 KG	56.5 KG

## VENT & OVERFLOW

The vent / overflow pipe must be extended and laid with a **continuous fall**, discharging to a safe and visible point. The pipe should not be directly connected to a closed waste, as taste problems may occur and should never be allowed to become blocked or restricted. One way this could be connected is via a tundish arrangement. 15mm copper or 'Speedfit' pipe should be used.

### **Note**

Although the machine will operate without this pipe being extended, failure to do so will mean the surroundings are susceptible to damage from any discharge

## ELECTRICAL CONNECTIONS

Cascade-6A boilers require fixed wiring to the rear terminal block. A means of disconnection must be provided in which at least 3mm separation between the live and neutral poles of the supply exists. ( Double pole isolating switch ).

The installation of a residual current device (RCD) having a rated residual operating current not exceeding 30 mA is advisable.

## USER INSTRUCTIONS



### **Commissioning**

During normal operation some external parts will become very hot, particularly the tap body. Care must be taken to avoid injury, a burn or scald.

Turn on the water supply and then switch on the electrical supply. The Wait/Ready light will flash yellow (indicating below temperature) and the unit will slowly fill with water (1.2 L/Min). When water passes the low level sensor (just below tap level) the elements will also be energized. When the normal operating water level is reached the solenoid will be disabled and the elements will continue to heat the boiler until full operating temperature has been reached. At this point the Wait/Ready light will show solid orange indicating that the boiler is full and up to temperature.

## Subsequent Use

After the boiler has finished the commissioning cycle, and water is drawn from the tap, water will be replaced in short cycles (small amount of water and then heat). The solenoid and elements will never be on at the same time unless the boiler is switched off and on again (re-setting commission mode). In normal use the boiler will always be at operating temperature indicated by the Wait/Ready light showing a solid (not flashing) colour. When the boiler is full and ready the light will be orange and when the boiler is only part full the light will be yellow.

### **Note:**

When the green service indicator light on the front of the boiler is showing solid colour, the machine has been starved of water for in excess of 20 minutes and the solenoid valve has been disabled to prevent damage to the solenoid coil through overheat. To re-energise the solenoid, the unit must be disconnected from the electrical supply and then switched back on, after first reinstating the water supply.

## SCALE

The production of scale is a natural phenomenon and commonly occurs in hot water systems. The nature of the scale produced and its rate of formation varies widely throughout the country. To ensure continuous, reliable operation, the boiler should be regularly de-scaled by a suitably qualified engineer. Suitable chemical de-scalants must only be used if the manufacturer's recommendations are strictly adhered to. This is to prevent health and safety issues, taste problems and potential damage to the appliance. Misuse of such chemicals is not covered by the product warranty.

The Cascade-6A boiler benefits from an integral scale inhibitor, **this is not** a scale eliminator and its effects will differ according to the water quality in your area. To ensure trouble free operation, periodically check for scale inside the boiling chamber. The production of scale is a natural phenomenon and some de-scaling may be required within the first 12 months. This is not covered under the product's warranty as it is not a fault.

## GENERAL OPERATION

- Hold a cup below the tap or place large vessels on the drip tray. Care must be taken to avoid injury through splashing or over-filling.
- To begin filling, pull the handle forward or push it backward – hot water begins to flow. If the tap is opened fully it can be locked open (for filling large vessels) in this state the boiler must never be left unattended.
- To stop filling, release the handle so it returns to the closed position. NEVER PASS YOUR HAND BENEATH THE NOZZLE.

## GENERAL NOTES

- Please retain these instructions for future reference
- Ensure that a suitable drip tray is positioned below the tap nozzle. This will help keep the surrounding work surfaces and floor free from drips or splashes. Various options are available and are outlined on the Accessories page of this booklet .
- All de-scaling and servicing must be performed by a suitably qualified engineer.

## CLEANING



Avoid using any abrasive materials. Wiping the outer casing with a damp cloth should be sufficient. Some stainless steel cleaning products may not be suitable for plastic and must not come in contact with the plastic fascia. Always disconnect the electrical supply before cleaning.

**The appliance must not be cleaned using a water jet.**

## SPARE PARTS

(Refer to centre pages for location).

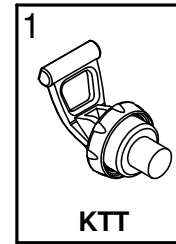

**KTT**  
TAP TOP ASSEMBLY

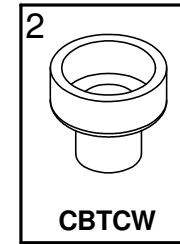

**CBTCW**  
TAP CUP WASHER

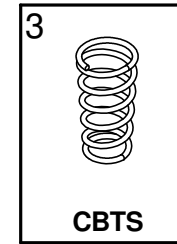

**CBTS**  
TAP SPRING

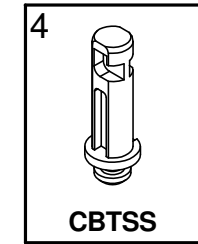

**CBTSS**  
TAP SLOTTED STEM

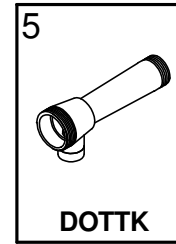

**DOTTK**  
DRAW OFF TAP BODY

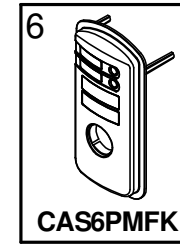

**CAS6PMFK**  
PLASTIC MOULDED FASCIA KIT

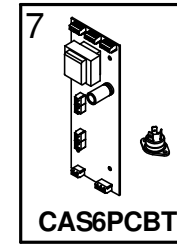

**CAS6PCBT**  
PRINTED CIRCUIT BOARD Inc. TRIAC

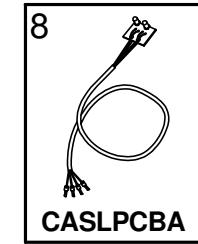

**CASLPCBA**  
LIGHT PCB

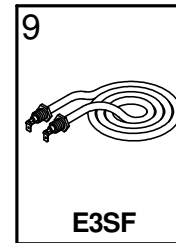

**E3SF**  
ELEMENT 3kW

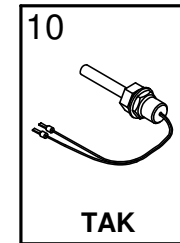

**TAK**  
THERMISTOR ASSEMBLY KIT

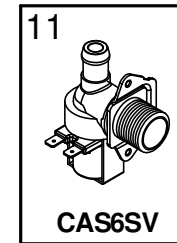

**CAS6SV**  
SOLENOID VALVE

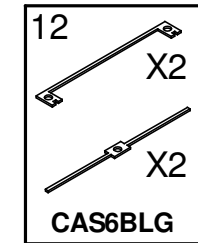

**CAS6BLG**  
BODY LID GASKET

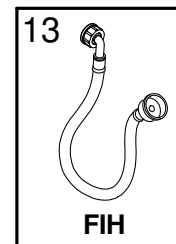

**FIH**  
WATER INLET HOSE

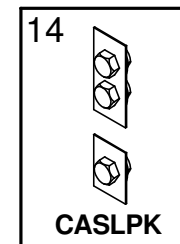

**CASLPK**  
LEVEL PROBES KIT

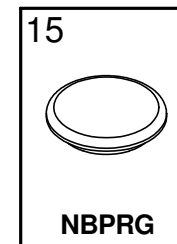

**NBPRG**  
PRESSURE RELIEF GROMMET

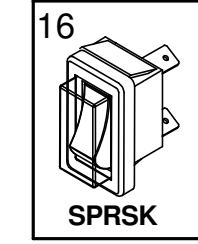

**SPRSK**  
SINGLE POLE ON/OFF SWITCH (INC. COVERS)

NB: Not to scale.

## SPARE PARTS

(Refer to centre pages for location).

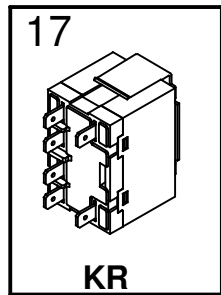

RELAY

## SERVICE INSTRUCTIONS

When the green service indicator light on the front of the boiler is showing solid colour, the machine has been starved of water for in excess of 20 minutes and the solenoid valve has been disabled to prevent damage to the solenoid coil through overheat. To re-energise the solenoid, the unit must be disconnected from the electrical supply and then switched back on, after first reinstating the water supply.

If the unit requires servicing the service indicator will flash a sequence of light pulses. A 2x or 3x-light pulse generally indicates that the low or normal level probes require de-scaling.

A 4x-light pulse means the water level has reached the high level sensor and the likelihood is that the normal level sensor requires de-scaling, or the machine has over-filled due to debris trapped in the solenoid valve. The debris can be removed by drawing plenty of water from the dispense tap, causing the solenoid valve to operate and flush out the obstruction. The machine will reset itself once the problem has cleared. If this does not rectify the problem, turn off the water supply and remove the flexible hose to check for debris in the valve's filter. The unit can be used normally while the service indicator is flashing a 4x pulse. For further assistance, contact our service department on 0113 249 6681 e-mail [service@calomax.co.uk](mailto:service@calomax.co.uk) or find a local service engineer at [www.calomax.co.uk](http://www.calomax.co.uk)

**Once the rear panel is removed, access to the Service Area has been gained. This access must be restricted to persons having knowledge and practical experience of the appliance, in particular as far as safety and hygiene are concerned.**

### De-scale

To gain access to internal components, the body lid must be removed. To do this the lid gasket seal must be broken.

If parts required are not identified, please contact Calomax Limited

## Exploded parts view

(To be read in conjunction with the spare parts list)

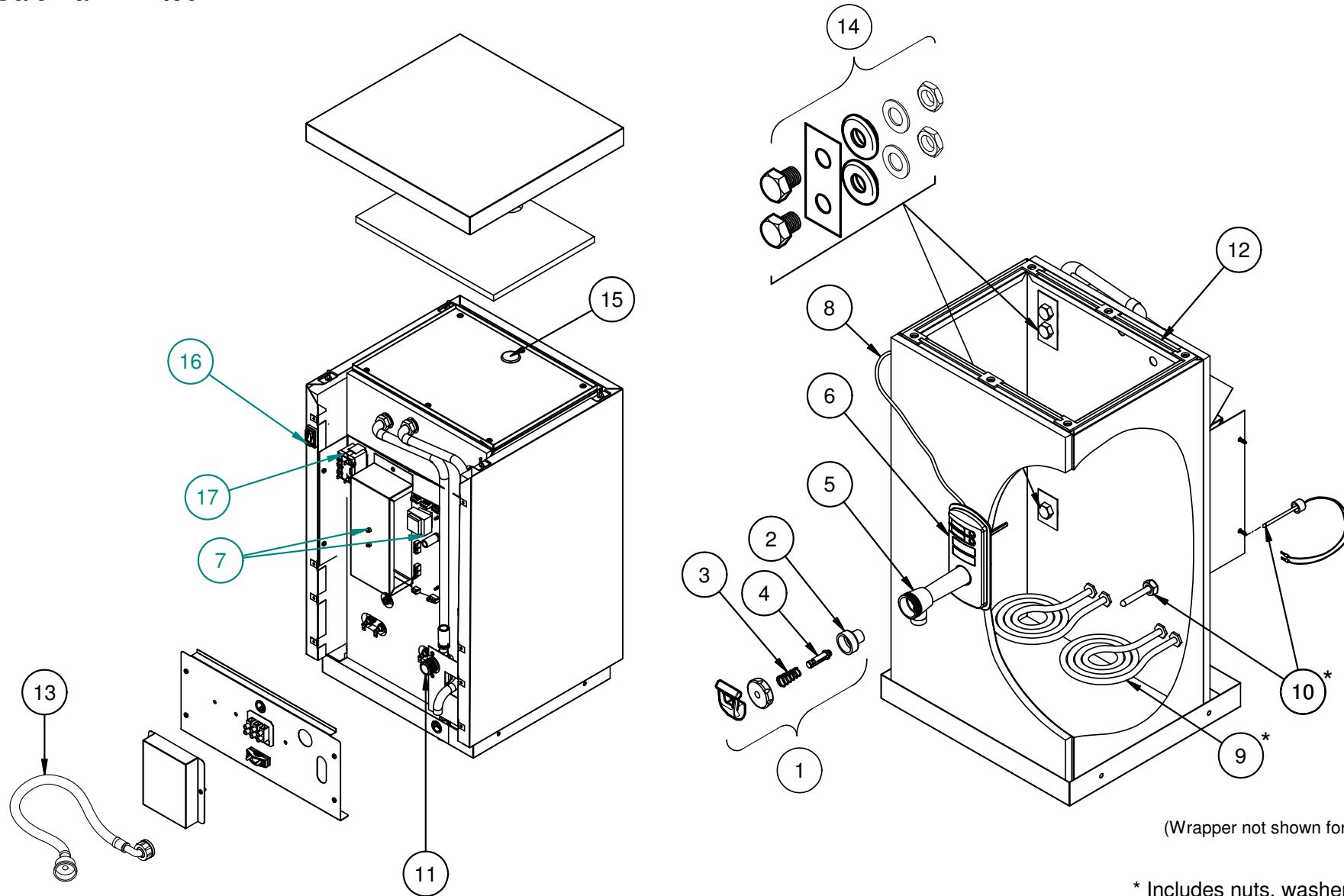

## SERVICE INSTRUCTIONS CONTINUED

**Note:** Whenever the body lid has been removed from the boiler a new lid gasket may be required to ensure a steam-tight joint. Damage to the unit caused by a poor lid seal is not covered by warranty.

Scale deposits should be removed from all internal surfaces, particularly the heating element, thermistor and level sensors by gently tapping or scraping. If the deposits are soft, use a nylon pad and flush out. Abrasive cleaning materials containing scouring powders and detergents must not be used, such materials can cause taste problems.

Suitable chemical de-scalants must only be used in accordance with the manufacturer's recommendations. This will prevent health and safety issues, taste problems and potential damage to the appliance. All trace of these chemicals must be removed from the appliance before re-commissioning the unit. Misuse of such chemicals is not covered by the product warranty.

**IMPORTANT Before re-commissioning the boiler it is important that all scale and moisture is removed from the level sensor insulating gaskets, to avoid a false signal being transmitted through the scale to the boiler body. Failure to remove this scale and/or moisture could cause the sensor to indicate to the PCB that water is covering the elements, whether or not water is present. In this situation the PCB could energise the elements causing failure. The elements are fitted with a none-resettable thermal cut-out, which will trip if an element is energized in air. In this case the boiler should be switched off, allowed to cool completely and the level sensors cleaned thoroughly as stated above, before replacing elements and switching the boiler back on. If in doubt, protect the elements by hand filling with water to the level of the draw-off tap before switching on the electrical supply to the boiler.**

Page 14

### General function

The printed circuit board (PCB) controls the heating and filling functions of the boiler by monitoring the thermistor and level sensors. The PCB also controls the external light unit to indicate the current state of the boiler. Red and yellow LED'S on the circuit board indicate whether the PCB has energised the element or solenoid respectively.

Should an element fail and need to be replaced, it may be necessary to replace the lid gasket to ensure a reliable steam-seal. **Note: the elements have a permanent 'Live' feed, and the 'Neutral' is switched.**

### Printed Circuit Board (PCB) replacement

In the event of a PCB failing and a replacement being required, full instructions will be supplied. It is important to note however, that the Triac device must be securely mounted against the copper heat-sink to ensure reliable heat dissipation. Heat transfer compound is also supplied with all replacement circuit boards.

### Adjusting the Water Temperature Set Point

The temperature potentiometer (Pot) is pre-set at Calomax and will only require adjustment in exceptional circumstances. Contact Calomax for advice.

Water boils at different temperatures depending on barometric pressure. The temperature should not be tuned higher than 98°C, or over boiling may occur during low barometric pressure conditions, causing steam to be ejected from the overflow pipe.

Page 15

# Accessories

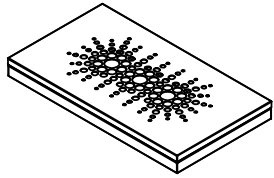

## Worktop-mounting Stainless Steel drip tray with drain outlet

Ref: SSDTWDK

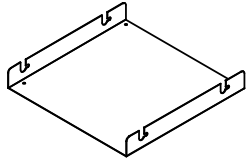

## Boiler securing clamp

(To fix boiler to a worktop)

Ref: C6C

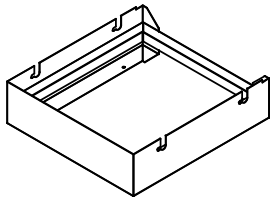

## Boiler Stand

(To increase height of boiler)

Ref: CAS6S##

(Where ## denotes **additional** clearance between worktop and tap nozzle)

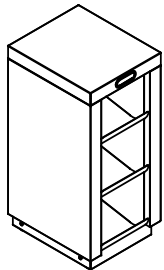

## Ingredient caddy

Ref: IC3 (3 bay) - *as shown*

IC4 (4 bay)

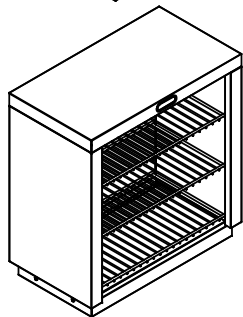

## Shelf unit

Ref: SHU

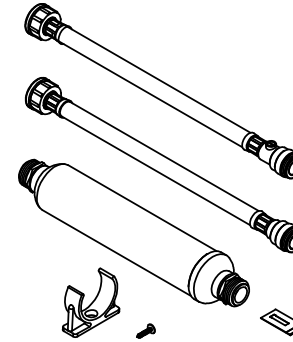

## Water filter kit

(To reduce taste & odour problems)

Ref. 10TOSCK

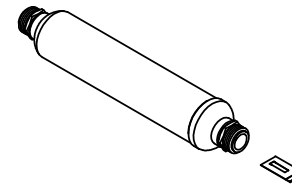

Ref. 10TOSC

(Filter & timestrip replacement for kit shown above)

## BASIC TROUBLE SHOOTING

Symptoms	Possible Cause	Remedy
No boiling water available	Broken tap top	Replace tap top (or component)
	Normal level sensor holding signal	De-scale / Clean / Dry
	Element(s) cut-out tripped	See "Important" note page 13
	Elements failed	Replace elements
Steam ejected from overflow	Excessive internal scale.	De-scale the boiler (Particularly thermistor)
	Faulty wiring to thermistors / faulty thermistors	Repair / replace as required
	Temperature controller needs adjusting	Lower operating temperature
	Element(s) failed to earth	Replace element(s)
Overflows	Defective Printed Circuit Board & / or Triac	Replace Circuit Board & Triac (Sold as a matched pair)
	Dirt in solenoid valve.	Clean solenoid filter and "work the boiler" or replace the solenoid -see Service Instructions .
Overflows	Level sensors require de-scaling or replacing	De-scale / replace sensors
	Printed circuit board faulty	Replace P.C.B

Wiring Schematic for Calomax Cascade-6A Water Boiler (with power switch)

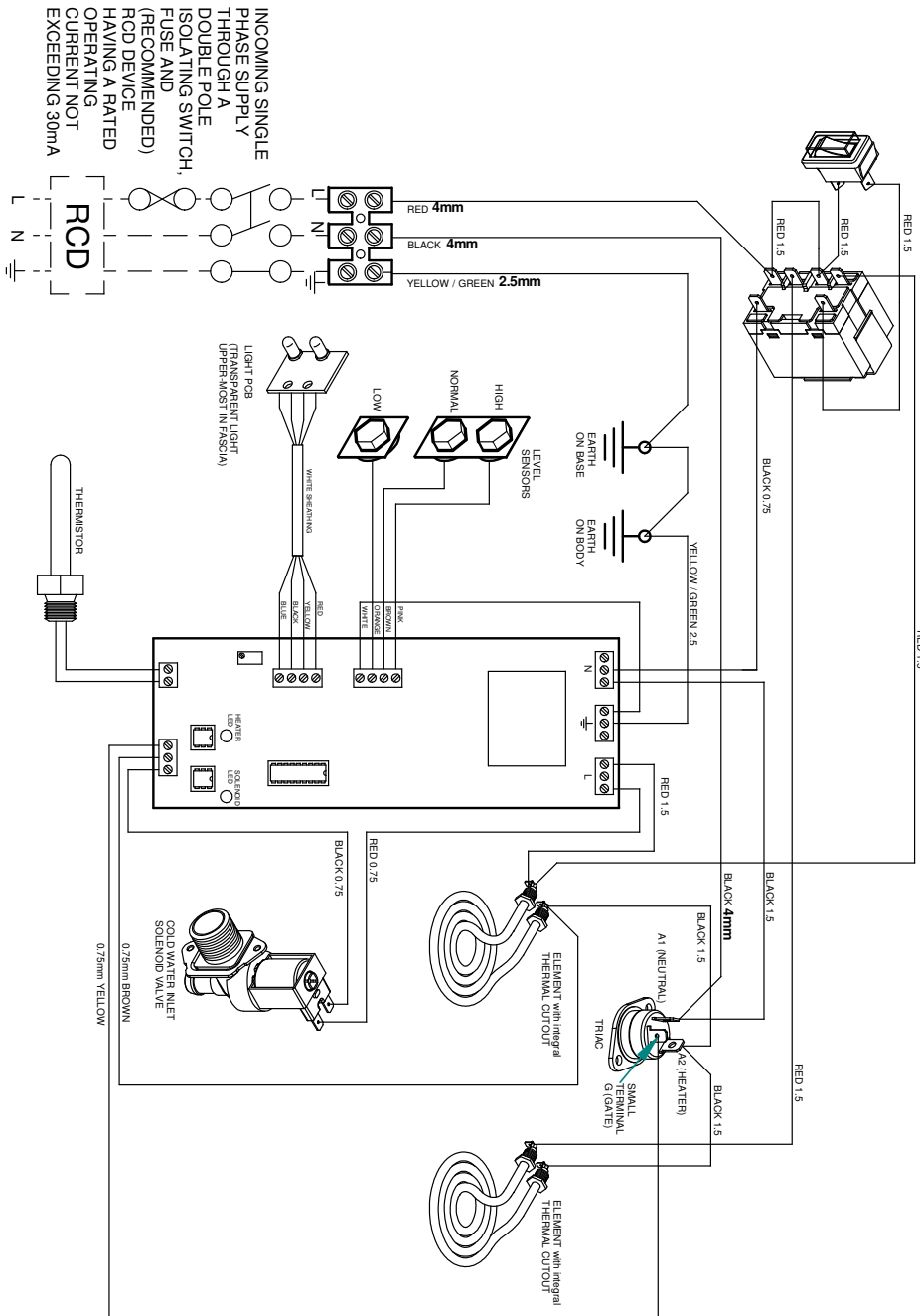

## WARRANTY GUARANTEE (UK Mainland customers only)

Calomax have manufactured water boilers in the UK for over 50 years. We are proud of our products and the back-up service we provide

Properly maintained and serviced, a Calomax boiler should last many years and we have no hesitation in providing a full 12 months parts and labour warranty for all models. Please complete and return the enclosed product registration form as soon as possible to activate this, **or register online at [www.calomax.co.uk](http://www.calomax.co.uk)** .

In addition, the Clipper, Kudos and Quantum models carry an additional 12 month back to base warranty.

Some factors are beyond our control and would invalidate the warranty offered. These include:

- Incorrect installation
- High / Low water pressure
- Incorrect voltage supply
- Accidental damage
- Limescale build-up

The last item can be a particular problem for water dispensing equipment in hard-water areas. All hot water equipment should be serviced and de-scaled by approved organisations on a regular basis to avoid a damaging build-up of limescale.

Although our boilers incorporate scale-inhibitor technology, we recommend that a taste, odour and scale filter should be fitted where appropriate.

Please visit our website [www.calomax.co.uk](http://www.calomax.co.uk) for details of our Service Partner Network and the range of filters and accessories available

SERVICE HISTORY AND NOTES

SERVICE HISTORY AND NOTES

PLEASE ENTER SERIAL NUMBER FOR FUTURE REFERENCE

Model	CASCADE- 6A
Serial Number	
Draw off capacity	18 Litres
Heat-up Time (Full capacity - first switch on)	48 Minutes
Max flow rate from tap (Boiler full)	4.5 Litres / Minute
Average flow rate from tap (During 18 litre Draw off)	2.8 Litres / Minute
Voltage	220 - 240 V ac 50 - 60 Hz
Power rating	6kW (max) single phase

Note: All measurements are approximate.

**PLEASE CONTACT OUR SERVICE DEPARTMENT FOR ASSISTANCE**

Calomax Limited, Lupton Avenue, Leeds LS9 7DD

Tel: 0113 249 6681

Fax: 0113 235 0358

e-mail: [service@calomax.co.uk](mailto:service@calomax.co.uk)